





Features :

- ▶ 13 Functions
- ▶ 10 Time ranges
- ▶ LED indications : Relay ON, Power ON
- ▶ Front knobs for time range, Time scale & Mode setting
- ▶ Slim, Space saving design

Certifications :  

Technical specifications

Display specifications	
Display	Power ON, Relay ON
Input specifications	
Accuracy setting	±5% of F.S.
Repeat	±0.5% or 50msec (F.S. = full scale)
Output specifications	
Relay contact	1 C/O (SPDT)
Relay rating	5A @250V AC or 24V DC
Functional specifications	
Modes	On delay (A)
	Interval (B)
	Cyclic equal OFF first (C)
	Cyclic equal ON first (Ci)
	Pulse output, 500ms fixed (D)
	Delay on break (E)
	Delay on make / Delay on break (F)
	Interval after break (H)
	Single shot (I)
	Retriggerable single shot (J)
	Latching relay (K)
	Delay on make with totalise (Ai)
	Interval with totalise (Bi)
Time Ranges	0.1 - 1 sec, 0.3 - 3 sec, 1 - 10 sec, 3 - 30 sec 0.1 - 1 min, 0.3 - 3 min, 1 - 10 min, 3 - 30 min 0.1 - 1 hr, 0.3 - 3 hr
Reset time	Less than 100 msec.
Resolution	0.1 Sec
Auxiliary supply specifications	
Supply voltage	20 to 240V AC (50/60 Hz), 12 to 240V DC
Power consumption	3.2VA max
Environmental specification	
Temperature operating	0 °C to 55 °C (32 °F to 131 °F)
Storage	-20 °C to 75 °C (-4 °F to 167 °F)
Humidity (non - condensing)	95% RH

Mechanical specifications

Size	17.5mm width
Mounting	Din Rail
Wire size (max)	1.5 sq.mm
Screw tightening torque	0.6 to 0.8 Nm
Weight	64 gm

Timing diagrams

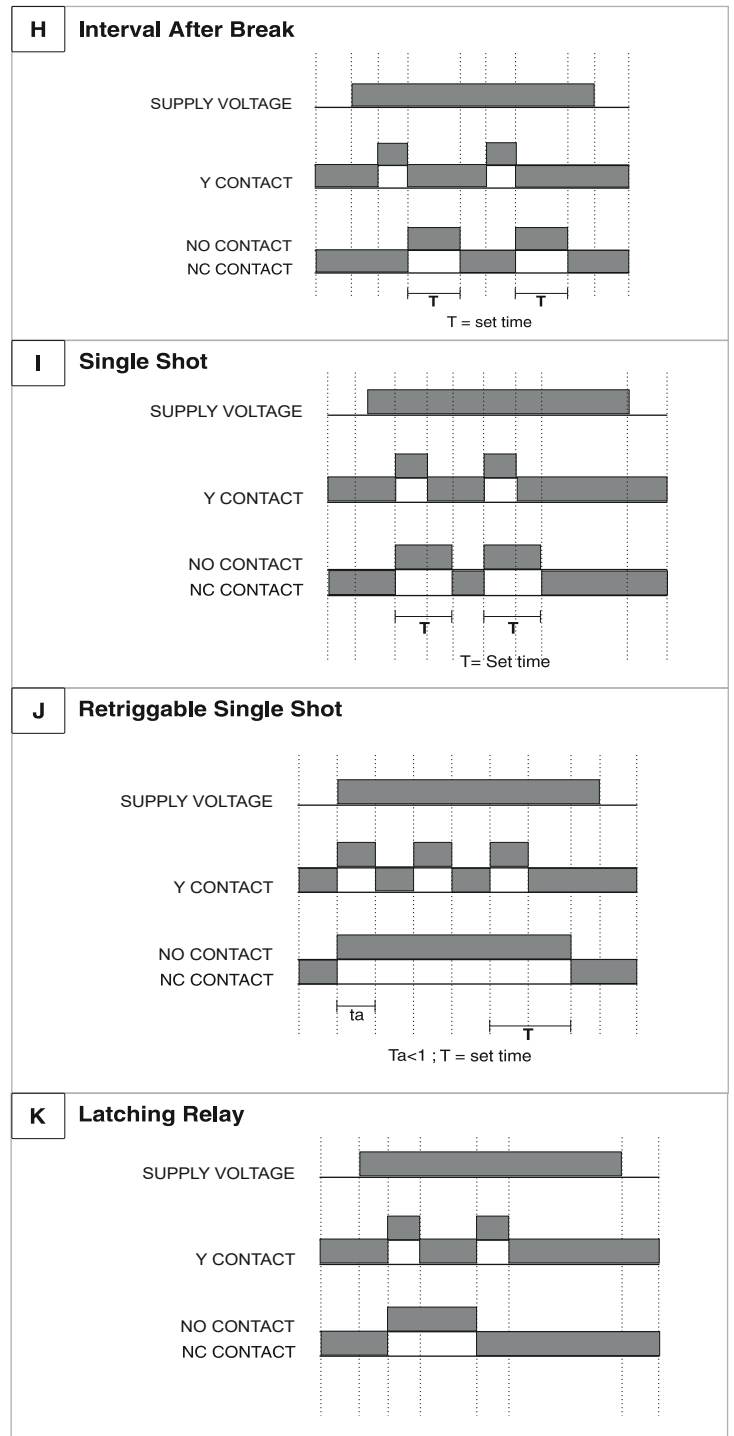
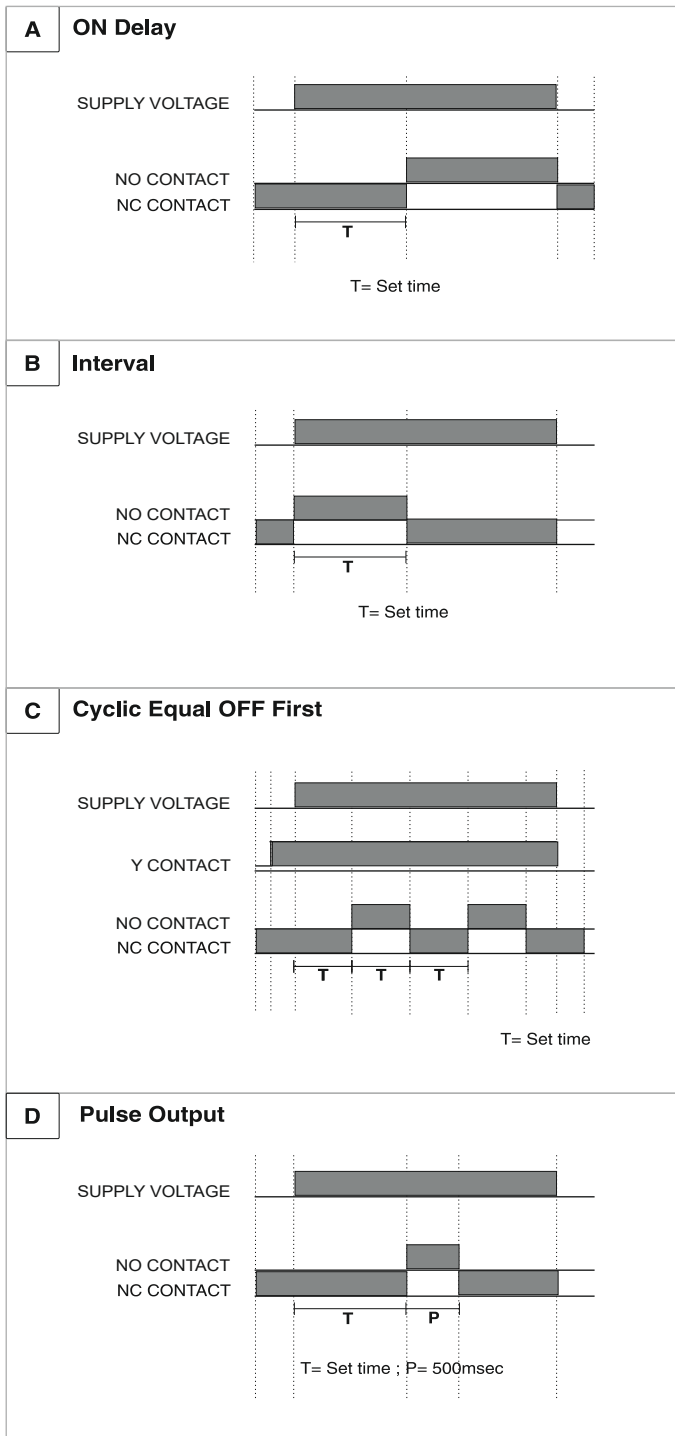

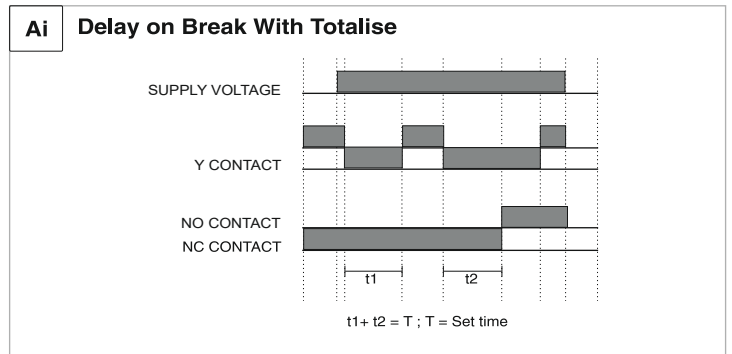
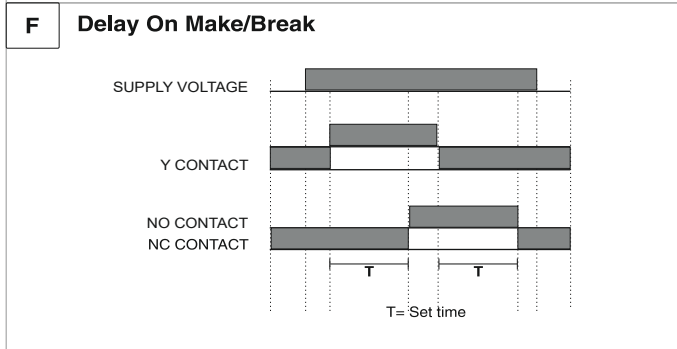
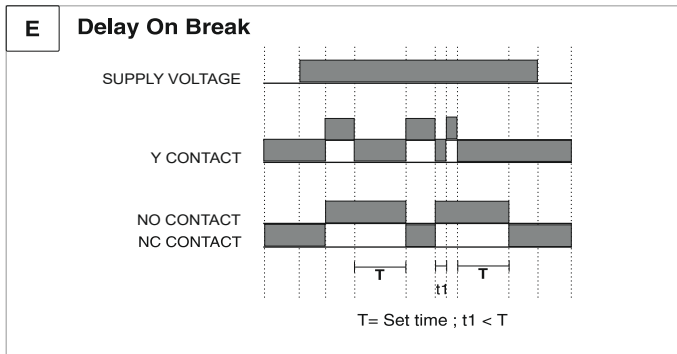

Dimensions (All are in mm)

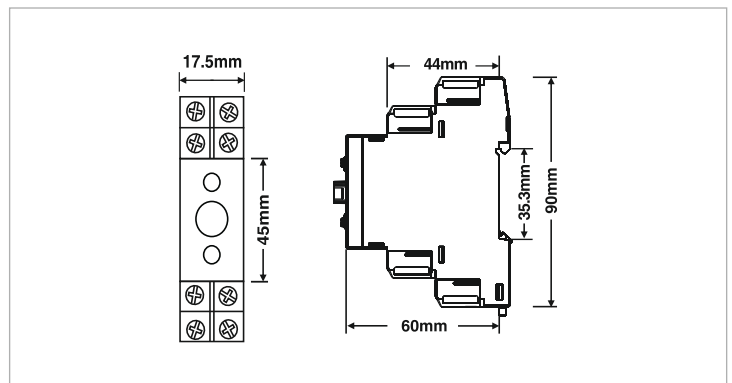

Compliance

Applicable EMI / EMC standards		
Product standard - IEC60255-1/IEC60947-5-1		
Category	Reference standards	Testing level
Electrostatic discharge	IEC 61000-4-2	Level-3
Electrical fast transient / Burst	IEC 61000-4-4	Level-4
Electromagnetic field	IEC 61000-4-3	Level-3
Surge	IEC 61000-4-5	Level-4
Conducted RF	IEC 61000-4-6	Level-2
Rated power frequency	IEC 61000-4-8	Level-4
Voltage dip / Short interruptions	IEC 61000-4-11	Level-3
Conducted emissions	CISPR-22	Class-A
Radiated emissions	CISPR-11	Class-B
Emission & Immunity	IEC 60255-26	
Safety	IEC 60255-27	

Terminal connections

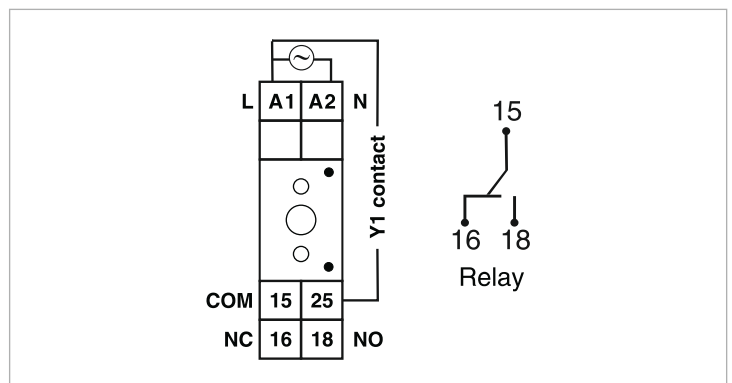

Ordering information

Product code	Supply voltage	Certification
600XU-A-1-CU	20 to 240V AC, 12 to 240V DC	CE US