

# PRODUCT SELECTION GUIDE



## AUTOMATION & PROCESS CONTROL



- PLCs
- HMI
- VFD
- Power Supply
- Temperature / PID
- Humidity
- Process
- Timers & Counters
- Solid State Relays

## ELECTRICAL MEASURING & PROTECTION



- Multifunction Meters
- Digital Panel Meters
- Analog Meters
- Current Transformers
- Line Monitoring
- Current Monitoring
- Pump Protection
- Motor Protection
- Time Switches
- Analog Timers

## POWER QUALITY & RENEWABLE



- VAR Generators
- Active Filters
- Hybrid Panels
- APFC
- Capacitors
- Static Voltage Regulator
- Solar On Grid Inverter

## METERS

3

Multifunction Meters  
Energy Meters  
Digital Panel Meters (VAF Meter, Volt Amp meter, Voltmeter, Ammeter)  
Analog Meters  
Current Transformers  
Ordering Information

## POWER QUALITY

15

Power Factor Controllers  
Capacitors  
Advanced Static Var Generators  
Power Quality Hybrid Solution  
Static Voltage Regulator

## SOLAR ON GRID INVERTER

21

## MONITORING / PROTECTION RELAYS

22

Line Monitoring Relay  
Auto Switch  
Voltage Monitoring Relay  
Current Monitoring Relay  
Earth Fault Relay / Earth Fault Current Transformer  
Earth Leakage Relay / Core Balance Current Transformer  
Motor Protection Relay  
Pump Protection Relay / Motor Protection Current Transformer  
Liquid Level Controllers / Liquid Level Sensor  
Thermistor Protection Relay / Annunciator  
Ordering Information

## DIGITAL TIME SWITCHES & TIME RELAY

31

Astronomical  
Daily / Weekly  
Analog Timer  
Ordering Information

## DIGITAL TIMERS

33

Thumbwheel Timers  
Programmable Timers  
Multifunction Timers  
Sequential Timer  
Time Interval Meter / Hour Meter  
Ordering Information

## COUNTERS

35

Digital Counters  
Speed Monitoring Relay  
Digital Timer-Counter  
Time Count Totaliser  
Ordering Information

## TEMPERATURE & PROCESS

38

Temperature Controllers  
PID Controllers  
Universal PID Controller  
Humidity Controllers  
Humidity + Temperature Controllers  
Accessories  
Cooling Controllers  
Process Indicators

## SOLID STATE RELAY

43

Ordering Information

## PLCs

46

MiBRX Series - Micro Modular PLC System  
Flexys Series - Flexible I/O PLC Solution  
Compact Series - UNIX, TWIX, DIGIX & MM303X

## ACCESSORIES

51

- Relay Modules  
- Data Converters  
- Communication Adapters & Cables

## STANDARD FUNCTION PRODUCTS

52

Ordering Information

## HMI & POWER SUPPLY

54

Human Machine Interface  
Din Rail Series  
Open Frame Series  
Battery Chargers  
Ordering Information

## VARIABLE FREQUENCY DRIVES (VFD)

58

Selec Range of VFDs  
Atsel Range of VFDs

## PANEL CUTOUT DIMENSION

61



**MFM384+**  
96(H) x 96(W) x 50(D)mm



**MFM384**  
96(H) x 96(W) x 50(D)mm



**MFM384-R-C**  
90(H) x 70(W) x 66.3(D)mm

<b>FEATURES</b>	<ul style="list-style-type: none"> <li>• Accuracy Class 0.5S</li> <li>• RTC (Year / Date / Hour)</li> <li>• Suppression current</li> <li>• %THD up to 31<sup>st</sup> level</li> <li>• %Unbalance for voltage and current</li> <li>• Demand measurement</li> <li>• RS485 MODBUS RTU protocol</li> </ul>	<ul style="list-style-type: none"> <li>• Accuracy Class 0.5S / Class 1</li> <li>• Import / Export energy</li> <li>• %THD up to 31<sup>st</sup> level</li> <li>• Demand measurement</li> <li>• RS485 MODBUS RTU protocol</li> </ul>	<ul style="list-style-type: none"> <li>• Accuracy Class 1</li> <li>• Import / Export energy</li> <li>• Demand measurement</li> <li>• RS485 MODBUS RTU protocol</li> </ul>
<b>DISPLAY</b>	LCD with backlight		
<b>DIGITS</b>	4 rows of 4 digits, Bar graph representation for current, 1 row of 9 digits for energy display	4 rows of 4 digits, Bar graph representation for current, 1 row of 8 digits for energy display	1 row of 4 digits, 2 rows of 7 digits
<b>ELECTRICAL CONNECTION</b>	1Ø - 2W, 2Ø - 3W, 3Ø - 3W, 3Ø - 4W		
<b>ACCURACY CLASS</b>	Class 0.5S	Class 0.5S / Class 1	Voltage (L - L / L - N), Current : ±0.5% of F.S., Power factor : ±0.01, Frequency : ±0.1% of F.S., Power (kW, kVA, kVA <sub>r</sub> ) : 1% of F.S., Energy (Active, Reactive, Apparent) : 1% of F.S.
<b>RATED INPUT VOLTAGE</b>	35 to 347V AC (L - N), 35 to 600V AC (L - L)	11 to 300V AC (L - N), 19 to 519V AC (L - L)	
<b>RATED INPUT CURRENT</b>	Nominal 5AAC (Min - 5mA; Max - 6A)	Nominal 5A AC (Min - 11mA; Max - 6A)	
<b>RESOLUTION</b>	For Energy : 0.001k (Auto resolution) For Power, Voltage, Current : Auto resolution For Power factor : 0.001, Frequency : 0.1Hz	For Energy : 0.01k, 0.1k, 1k, 0.01M, 0.1M, 1M (Depending upon CT ratio x PT ratio), For Power, Voltage, Current : Auto resolution, For Power factor : 0.01, Frequency : 0.1Hz	
<b>CT PRIMARY</b>	1 / 5A to 32.76kA (Programmable for any value)	1 / 5A to 10kA (Programmable for any value)	
<b>CT SECONDARY</b>	1 / 5A (Programmable)		
<b>PT PRIMARY</b>	100V to 999kV (Programmable for any value)	100V to 500kV (Programmable for any value)	
<b>PT SECONDARY</b>	100, 110, 115, 120V AC (Programmable)	100 to 500V AC (L - L) (Programmable for any value)	
<b>COMMUNICATION</b>	RS485 MODBUS RTU protocol		
<b>MEASURING PARAMETERS</b>	Voltage (L - L / L - N) (Individual / Average), Current (Individual / Average), Frequency, Power factor (Individual / Total), Active, Reactive & Apparent Power (Individual / Total), Active, Reactive & Apparent Energy (Total)		
<b>ADDITIONAL FUNCTIONS</b>	Cybersecurity, Neutral current, RTC (Year / Date / Hour), RPM (monitors generator speed), DG sensing, Displacement PF, Demand measurement, Import / Export energy, Phase sequence indication, Run hour, Load hour	Current connection indication, Phase sequence indication, Run hour, Auxiliary interrupts, Import / Export energy, Demand measurement	Demand measurement, Import / Export energy
<b>SUPPLY VOLTAGE</b>	40 to 300V AC / DC	85 to 300V AC	85 to 270V AC



**MFM376+ (Dual Source)**  
96(H) x 96(W) x 49(D)mm



**MFM376+**  
96(H) x 96(W) x 49(D)mm



**MFM376**  
96(H) x 96(W) x 49(D)mm

<b>FEATURES</b>	<ul style="list-style-type: none"> <li>• Accuracy Class 0.5S</li> <li>• DG sensing</li> <li>• %THD up to 31<sup>st</sup> level</li> <li>• %Unbalance for voltage and current</li> <li>• Demand measurement</li> <li>• RS485 MODBUS RTU protocol</li> </ul>	<ul style="list-style-type: none"> <li>• Accuracy Class 1</li> <li>• Single pulse output</li> <li>• %THD up to 31<sup>st</sup> level</li> <li>• %Unbalance for voltage and current</li> <li>• Demand measurement</li> <li>• RS485 MODBUS RTU protocol</li> </ul>	<ul style="list-style-type: none"> <li>• Accuracy Class 1</li> <li>• Single pulse output</li> <li>• %THD up to 31<sup>st</sup> level</li> <li>• Demand measurement</li> <li>• RS485 MODBUS RTU protocol (MFM376-C-CE)</li> </ul>
<b>DISPLAY</b>	7 segment LED		
<b>DIGITS</b>	3 rows of 4 digits, 2 rows of 8 digits for energy display		3 rows of 4 digits, 2 rows of 8 digits for energy display
<b>ELECTRICAL CONNECTION</b>	1Ø - 2W, 2Ø - 3W, 3Ø - 3W, 3Ø - 4W		
<b>RATED INPUT VOLTAGE</b>	11 to 350V AC (L - N), 19 to 600V AC (L - L)		11 to 300V AC (L - N), 19 to 519V AC (L - L)
<b>RATED INPUT CURRENT</b>	Nominal 5AAC (Min - 10mA; Max - 6A)		Nominal 5A AC (Min - 14mA; Max - 6A)

	MFM376+ (Dual Source)	MFM376+	MFM376
RESOLUTION	For energy : 0.001k (Auto resolution), For Current, Voltage, Power : Auto resolution, For Power factor : 0.001		For energy : 0.01k, 0.1k, 1k, 0.01M, 0.1M, 1M (Depending upon CT ratio x PT ratio), For Current, Voltage, Power : Auto resolution, For Power factor : 0.001
ACCURACY	Voltage (L - N / L - L) : $\pm 0.5\%$ of F.S., Current : $\pm 0.5\%$ of F.S., Power Factor : $\pm 0.01$ Frequency : $\pm 0.1\%$ For L - N Voltage >20V, For L - L Voltage >35V, Power (Active, Reactive, Apparent) : 1%, Energy (Active, Reactive, Apparent) : Class 0.5S	Voltage (L - N / L - L) : $\pm 0.5\%$ of F.S., Current : $\pm 0.5\%$ of F.S., Power Factor : $\pm 0.01$ Frequency : $\pm 0.1\%$ For L - N Voltage >20V, For L - L Voltage >35V, Power (Active, Reactive, Apparent) : 1%, Energy (Active, Reactive, Apparent) : Class 1	
CT PRIMARY	1 / 5A to 32.76kA (Programmable for any value)		1 / 5A to 10kA (Programmable for any value)
CT SECONDARY	1 / 5A (Programmable)		
PT PRIMARY	100V to 999kV (Programmable for any value)		100V to 500kV (Programmable for any value)
PT SECONDARY	100 to 500V AC (Programmable for any value)		
COMMUNICATION	RS485 MODBUS RTU protocol		RS485 MODBUS RTU protocol (applicable for MFM376-C-CE)
MEASURING PARAMETERS	Voltage (L - L / L - N) (Individual / Average), Current (Individual / Average), Frequency, Power factor (Individual / Total), Active, Reactive & Apparent Power (Individual / Total), Active, Reactive & Apparent Energy (Total)		
ADDITIONAL FUNCTIONS	Neutral current, RPM (Monitors generator speed), Displacement PF, DG sensing, % unbalance for voltage and current, %THD up to 31 <sup>st</sup> level, Run Hour, Auxiliary Interrupts,Phase angle	Neutral current, RPM (Monitors generator speed), Displacement PF, Pulse output, % unbalance for voltage and current, %THD up to 31 <sup>st</sup> level, Run Hour, Auxiliary Interrupts,Phase angle	Run Hour, Auxiliary Interrupts,Phase angle
SUPPLY VOLTAGE	40 to 300V AC / DC		



**MFM284**  
72(H) x 72(W) x 90.15(D)mm



**MFM383A**  
96(H) x 96(W) x 50(D)mm



**MFM391**  
96(H) x 96(W) x 49(D)mm

FEATURES	<ul style="list-style-type: none"> <li>• Compact size</li> <li>• Single pulse output</li> <li>• %THD up to 31<sup>st</sup> level</li> <li>• Demand measurement</li> </ul>	<ul style="list-style-type: none"> <li>• Single pulse output</li> <li>• Energy (Active / Reactive / Apparent)</li> </ul>	<ul style="list-style-type: none"> <li>• 3Ø (Voltage, Current, PF, Frequency)</li> <li>• 3Ø Power (Active, Reactive, Apparent)</li> <li>• RPM</li> <li>• Run Hour</li> </ul>
DISPLAY	LCD with backlight		7 segment LED
DIGITS	3 rows of 4 digits, 7½ digits for energy display		3 rows of 3 digits
ELECTRICAL CONNECTION	1Ø - 2W, 2Ø - 3W, 3Ø - 3W, 3Ø - 4W		3Ø - 3W, 3Ø - 4W
ACCURACY CLASS	Voltage (L - N / L - L) : $\pm 0.5\%$ of F.S., Current : $\pm 0.5\%$ of F.S., Power Factor : $\pm 0.01$ Frequency : $\pm 0.1\%$ For L - N Voltage >20V, For L - L Voltage >35V, Power (Active, Reactive, Apparent) : 1%, Energy (Active, Reactive, Apparent) : Class 1		Voltage (L - N / L - L) : $\pm 0.5\%$ of F.S., Current : $\pm 0.5\%$ of F.S., Power Factor : $\pm 0.01$ Frequency : $\pm 0.1\%$ For L - N Voltage >11V, For L - L Voltage >35V, Power (Active, Reactive, Apparent) : 1%,
RATED INPUT VOLTAGE	11 to 300V AC (L - N), 19 to 519V AC (L - L)		
RATED INPUT CURRENT	Nominal 5A AC (Min - 11mA ; Max - 6A)		Nominal 5A AC (Min - 20mA ; Max - 6A)
RESOLUTION	For energy : 0.01k, 0.1k, 1k, 0.01M, 0.1M, 1M (Depending upon CT ratio x PT ratio), For Power, Voltage & Current : Auto resolution, For Power factor : 0.001	For energy : 0.1k, 1k (Depending upon CT ratio x PT ratio) For Power, Voltage & Current : Auto resolution, For Power factor : 0.001	For Power, Voltage, Current : Auto Resolution, For Power Factor : 0.01
CT PRIMARY	1 / 5A to 10kA (Programmable for any value)		
CT SECONDARY	1 / 5A (Programmable)		
PT PRIMARY	100V to 500kV (Programmable for any value)	100V to 10kV (Programmable for any value)	100V to 500kV (Programmable for any value)
PT SECONDARY	100 to 500V AC (L - L) (Programmable for any value)		
COMMUNICATION	RS485 MODBUS RTU protocol (Optional)		---
MEASURING PARAMETERS	Voltage (L - L / L - N) (Individual / Average), Current (Individual / Average), Frequency, Power factor (Individual / Total), Active, Reactive & Apparent Power (Individual / Total), Active, Reactive & Apparent Energy (Total)		Voltage (L - L / L - N) (Individual / Average), Current (Individual / Average), Frequency, Powerfactor (Individual / Average), Active, Reactive & Apparent Power (Individual / Average)
ADDITIONAL FUNCTIONS	Current connection indication, Run hour, Auxiliary interrupts, Import / Export energy	---	RPM, Run hour
SUPPLY VOLTAGE (AC : 50 / 60 Hz)	85 to 270V AC		

## Plug-N-Wire Multifunction Meters



**MRJ4M-QUAD**  
90(H) x 70(W) x 66.3(D)mm

<b>FEATURES</b>	<ul style="list-style-type: none"> <li>• Energy (Active, Reactive)</li> <li>• RJ45 connector current input</li> <li>• Single pulse output</li> <li>• Max demand of power</li> <li>• Self powered</li> </ul>
<b>DISPLAY</b>	LCD with backlight
<b>DIGITS</b>	1 row of 4 digits, 2 rows of 7 digits
<b>ELECTRICAL CONNECTION</b>	1Ø - 2W, 3Ø - 4W
<b>RATED INPUT VOLTAGE</b>	60 to 300V AC (L - N), 104 to 520V AC (L - L)
<b>FREQUENCY</b>	45 to 65Hz
<b>RESOLUTION</b>	0.01k, 0.1k, 1k, 0.01M, 0.1M, 1M (depending upon CT ratio x PT ratio), For Power, Voltage : Auto resolution, For Power factor : 0.01
<b>ACCURACY CLASS</b>	Voltage (L - L / L - N), Current : ±0.5% of F.S., Power factor : ±0.01, Frequency : ±0.1% of F.S., Power (kW, kVA, kVAr) : 1% of F.S., Energy (Active, Reactive, Apparent) : 1% of F.S.
<b>CT PRIMARY</b>	1A to 1kA (Programmable for any value), <b>Plug-N-Wire CTs to be used</b>
<b>CT SECONDARY</b>	330mV through Plug-N-Wire CT output
<b>PT PRIMARY</b>	100V to 10kV (Programmable for any value)
<b>PT SECONDARY</b>	100 to 500V AC (L - L) (Programmable for any value)
<b>MEMORY RETENTION FOR ENERGY</b>	10 years
<b>COMMUNICATION</b>	RS485 MODBUS RTU protocol
<b>INDICATIONS</b>	LCD : Max demand of power, Communication in progress; LED : Integration of energy
<b>MEASURING PARAMETERS</b>	Voltage (L - L / L - N) (Individual / Average) of 4 Channels, Current (Individual / Average) of 4 Channels, Power (Active, Reactive & Apparent) (Individual) of 4 Channels, Power factor & Frequency of 4 Channels, Energy (Active, Reactive & Apparent) (Individual / Total) of 4 Channels
<b>SUPPLY VOLTAGE</b> (AC : 50 / 60 Hz)	60 to 300V AC, Self powered (V1, N)

## Plug-N-Wire Multifunction Meters



**MRJ4M**  
90(H) x 70(W) x 62(D)mm



**MRJ4M-SL**  
90(H) x 70(W) x 62(D)mm



**MRJ385**  
96(H) x 96(W) x 50(D)mm

<b>FEATURES</b>	<ul style="list-style-type: none"> <li>• Energy (Active, Reactive)</li> <li>• RJ45 connector current input</li> <li>• Single pulse output</li> <li>• Max demand of power</li> <li>• Self powered</li> </ul>	<ul style="list-style-type: none"> <li>• Energy (Active, Reactive)</li> <li>• Split load, RJ45 connector current input</li> <li>• 2 pulse outputs</li> <li>• Max demand of power</li> <li>• Self powered</li> </ul>	<ul style="list-style-type: none"> <li>• Energy (Active, Reactive, Apparent)</li> <li>• RJ45 connector current input</li> <li>• Single pulse output</li> <li>• Demand measurement</li> <li>• Self powered</li> <li>• %THD up to 31<sup>st</sup> level</li> </ul>
<b>DISPLAY</b>	LCD with backlight		
<b>DIGITS</b>	2 rows of 4 digits, 1 row of 7 digits to show electrical parameters	4 rows of 4 digits, Bar graph representation for current, 1 row of 8 digits for energy display	
<b>ELECTRICAL CONNECTION</b>	1Ø - 2W, 3Ø - 4W		
<b>RATED INPUT VOLTAGE</b>	60 to 300V AC (L - N), 104 to 520V AC (L - L)	100 to 240V AC (L - N), 173 to 415V AC (L - L)	
<b>RESOLUTION</b>	For Energy : 0.01K, 0.1K, 1K, 0.01M, 0.1M, 1M (Depending upon CT ratio x PT ratio), For Power, Voltage, Current : Auto resolution For Power factor : 0.01		
<b>CT PRIMARY</b>	5A to 10kA (Programmable for any value), <b>Plug-N-Wire CTs to be used</b>		
<b>CT SECONDARY</b>	330mV through Plug-N-Wire CT output		
<b>PT PRIMARY</b>	100V to 10kV (Programmable for any value)	100V to 500kV (Programmable for any value)	
<b>PT SECONDARY</b>	100 to 500V AC (L - L) (Programmable for any value)	173 to 415V AC (L - L) (Programmable for any value)	
<b>COMMUNICATION</b>	RS485 MODBUS RTU protocol		
<b>INDICATIONS</b>	LCD : Max demand of power, communication in progress ; LED : Integration of energy	LCD : Max / Min demand of power, communication in progress ; Integration of energy, Unit in configuration menu	

## Plug-N-Wire Multifunction Meters

	MRJ4M	MRJ4M-SL	MRJ385
MEASURING PARAMETERS	Voltage (L - L / L - N) (Individual / Average), Current (Individual / Average), Frequency, Power factor (Individual / Average), Active, Reactive & Apparent power (Individual / Total), Total Active & Reactive energy, Demand (Max active power, Max apparent power)	Voltage (L - L / L - N) (Individual / Average), Current (Individual), Frequency, Power factor (Individual / Average), Active, Reactive, Apparent power (Individual / Total), Total Active & Reactive energy (Current input-1 plus current Input-2), Demand (Max active power, Max apparent power)	Voltage (L - L / L - N) (Individual / Average), Current (Individual / Average), Frequency, Power factor (Individual / Average), Active, Reactive, Apparent power (Individual / Total), Active, Reactive, Apparent energy [Phase wise & Total (Import / Export)], Demand (Min / Max active power, Min / Max reactive power, Max apparent power), Harmonics individual for voltage & Current up to 31 <sup>st</sup> level.
SUPPLY VOLTAGE (AC : 50 / 60 Hz)	60 to 300V AC, Self powered (V1, N)		100 to 240V AC, Self powered (V1, N)

## Plug-N-Wire Current Transformers



**PWCT - 15 / 30** Primary current : 60A to 160A    
**PWCT - 16 / 20** Primary current : 60A to 160A    
**PWCT - 21 / 25** Primary current : 60A to 250A    
**PWCT - 31 / 31** Primary current : 150A to 630A    
**PWCT - 54 / 50** Primary current : 800A to 1600A

FEATURES	
	<ul style="list-style-type: none"> <li>• RJ45 connector, 330mV output</li> <li>• Safe to leave transformers on load with output disconnected</li> <li>• Foot, busbar or DIN rail mounting</li> <li>• Fits standard moulded circuit breaker frame sizes</li> <li>• Available in 21 x 25mm, 31 x 31mm, 54 x 50mm apertures</li> <li>• 15 x 30mm &amp; 16 x 20mm aperture sizes available on special request</li> </ul>

## Plug-N-Wire Accessories

	<p>PWCBL_CON-F-3 PWCBL_CON-F-1</p>	<p>PWCBL_CON-M/F-3 PWCBL_CON-M/F-1</p>	<p>PWCON-Male PWCON-Female</p>
DESCRIPTION	Power cable with Female type connector, 1 & 3 Meter length	Daisy chain cable to loop MRJ meters with Male & Female type connectors, 1 & 3 Meter length	Voltage connector Male / Female
	<p>CTV Converter 1A/330mV</p>	<p>PWADP-5A</p>	<p>PWADP-1A</p>
DESCRIPTION	Converter used with PLCTs for MRJ multifunction meter series	5A adapter to use with conventional CT for MRJ4M, MRJ4M-SL & MRJ385-G-PNW	1A adapter to use with conventional CT for MRJ4M-QUAD meter

**Additional accessories :** ACH-003, ACH-004, AC-IOEXP-03, AC-USB-RS485-02, AC-USB-RS485-03 (On page no. 51)



**EM306**  
96(H) x 96(W) x 50(D)mm



**EM306-C-D**  
96(H) x 96(W) x 50(D)mm



**EM368**  
96(H) x 96(W) x 50(D)mm

<b>FEATURES</b>	<ul style="list-style-type: none"> <li>• 3Ø Active energy</li> <li>• Single pulse output</li> </ul>	<ul style="list-style-type: none"> <li>• Dual Input Meter (Mains / D.G)</li> <li>• 3Ø Power (Active / Reactive)</li> <li>• 3Ø Energy (Active / Reactive)</li> <li>• Power factor (Phase / Average)</li> </ul>	<ul style="list-style-type: none"> <li>• Pulse output for energy</li> <li>• Power (Active / Reactive)</li> <li>• Energy (Active / Reactive / Apparent)</li> </ul>
<b>DISPLAY</b>	7 segment LED		LCD with backlight
<b>DIGITS</b>	1 row of 6 digits		1 row of 8 digits
<b>ELECTRICAL CONNECTION</b>	1Ø - 2W, 2Ø - 3W, 3Ø - 3W, 3Ø - 4W		
<b>RATED INPUT VOLTAGE</b>	11 to 300V AC (L - N), 19 to 519V AC (L - L)		
<b>RATED INPUT CURRENT</b>	Nominal 5AAC (Min - 50mA ; Max - 6A )		Nominal 5AAC (Min - 11mA ; Max - 6A )
<b>RESOLUTION</b>	For Energy : 0.01k, 0.1k, 1k, 0.01M, 0.1M, 1M	For energy : 0.01k, 0.1k, 1k, 0.01M, 0.1M, 1M (Depending upon CT ratio x PT ratio) For Power : Auto resolution, For Power factor : 0.001	For energy : 0.01k, 0.1k, 1k, 0.01M, 0.1M, 1M, 10M (Depending upon CT ratio x PT ratio) For Power : Auto resolution, For Power factor : 0.01
<b>ACCURACY</b>	Active energy : Class 1	Active / Apparent power : ±1%, Reactive power : ±2%, Power factor : 0.01, Active energy : Class 1, Reactive energy : Class 2	Active Energy : Class 1, Reactive / Apparent Energy : ±1% Active / Reactive power : ±1%, PF & Avg. PF : ±1%
<b>POWER CONSUMPTION</b>	8VA max		
<b>CT PRIMARY</b>	1 / 5A to 10kA (Programmable for any value)		
<b>CT SECONDARY</b>	1 / 5A (Programmable)		
<b>PT PRIMARY</b>	100V to 500kV (Programmable for any value)		
<b>PT SECONDARY</b>	100 to 500V AC (L - L) (Programmable for any value)		
<b>COMMUNICATION</b>	---	RS485 MODBUS RTU protocol	
<b>MEASURING PARAMETERS</b>	Active Energy	Power & Energy (Total Active / Reactive), Power factor (Individual & Average)	Power (Total Active / Reactive), Energy (Total Active / Reactive / Apparent), Power factor (Individual & Average)
<b>LED INDICATIONS</b>	CT Reverse detection, Kilo, Mega	CT Reverse detection, Kilo, Mega, Communication, DG	Integration of energy, Resolution is 10, CT Reverse detection, Communication in progress, Pulse output (All Indications on LCD)
<b>SUPPLY VOLTAGE</b> (AC : 50 / 60 Hz)	85 to 276 V AC		



**EM2M-1CH-DC**  
90(H) x 35(W) x 60(D)mm



**EM2M-1P-C-100A**   **EM2M-1P-W-100A**  
90(H) x 35(W) x 66.3(D)mm



**EM4M-3P-C-100A**   **EM4M-3P-W-100A**  
90(H) x 70(W) x 66.3(D)mm

<b>FEATURES</b>	<ul style="list-style-type: none"> <li>• Single channel DC meter</li> <li>• Voltage input up to 1000V DC</li> <li>• Current input using DC shunt (50 to 100mV)</li> <li>• Options available (Relay output / Data Logging feature up to 2MB</li> <li>• RS485 Modbus RTU protocol</li> </ul>	<ul style="list-style-type: none"> <li>• 1Ø, 100A direct connection</li> <li>• Multifunction parameter monitoring</li> <li>• Import / Export energy</li> <li>• 2 Pulse outputs</li> <li>• Secured in-built WiFi, MQTT protocol based (Applicable for EM2M-1P-W-100A)</li> </ul>	<ul style="list-style-type: none"> <li>• 3Ø, 100A direct connection</li> <li>• Dual input meter (Mains / D.G)</li> <li>• Multifunction parameter monitoring</li> <li>• Import / Export energy</li> <li>• 2 Pulse outputs</li> <li>• Secured in-built WiFi, MQTT protocol based (Applicable for EM4M-3P-W-100A)</li> </ul>
<b>DISPLAY</b>	7 segment LED	LCD with backlight / Blind display	LCD with backlight
<b>DIGITS</b>	1 row of 4 digits	1 row of 7 digits / No digits	1 row of 4 digits & 2 rows of 7 digits
<b>ELECTRICAL CONNECTION</b>	1Ø - 2W		
<b>RATED INPUT VOLTAGE</b>	0 to 1000V DC	176 to 276V AC (L - N)	85 to 285V AC (L - N) ; 148-494V AC (L - L)
<b>RATED INPUT CURRENT</b>	-999A to 999A DC	Ib : 10A (Imin - 500mA, IMax - 100A)	Ib : 10A (Imin - 40mA, IMax - 100A)
<b>RESOLUTION</b>	For Voltage : 0.1V, Current : 0.1A, Power & Energy : 0.1k	For Energy : 0.01k, For Power, Voltage, Current : Auto resolution, For Power factor : 0.01	
<b>ACCURACY</b>	Voltage, Current & Power : ±0.5%, Energy : Class 0.5	Voltage (L - N), Current : ±0.5% of F.S., Power factor : ±0.01, Frequency : ±0.1% of F.S. Power (kW, kVA, kVAR) : 1% of F.S., Active energy : Class 1, Reactive energy : Class 2	
<b>COMMUNICATION</b>	RS485 MODBUS RTU protocol	RS485 MODBUS RTU protocol / Wi-Fi, MQTT protocol	RS485 MODBUS RTU protocol / Wi-Fi, MQTT protocol
<b>MEASURING PARAMETERS</b>	Voltage, Current, Power, Import / Export Energy	Voltage, Current, Frequency, Power factor, Import / Export, Max demand for power	Mains/DG Voltage, Current, Frequency, Power factor, Power, Energy, Active, Reactive (Import / Export) Energy, Max demand power
<b>LED INDICATIONS</b>	V, I, P, IM, EX, MF	LED-2 for Pulse output 1, Pulse output 2      Power LED, Network LED	LED-2 for Pulse output 1, Pulse output 2      Pulse indication, Network indication
<b>SUPPLY VOLTAGE</b>	18 to 30V DC	176 to 276V AC (L-N), Self powered	85 to 285V AC (L - N), 120 to 494V AC (L - L) DG Sensing : 85 to 285V AC, Self - Powered



**VAF36A**  
96(H) x 96(W) x 50(D)mm



**VAF39A-1**  
96(H) x 96(W) x 50(D)mm

<b>FEATURES</b>	<ul style="list-style-type: none"> <li>• 3Ø (True RMS) Voltage</li> <li>• 3Ø (True RMS) Current</li> <li>• Frequency</li> <li>• RUN hour / RPM measurement</li> <li>• Bar graph for current representation</li> </ul>	<ul style="list-style-type: none"> <li>• 3Ø (True RMS) Voltage</li> <li>• 3Ø (True RMS) Current</li> <li>• Frequency</li> <li>• RUN hour / RPM measurement</li> </ul>
<b>DISPLAY</b>	LCD with backlight	7 segment LED
<b>DIGITS</b>	3 rows of 3 digits, Bar graph representation of current	3 rows of 3 digits
<b>ELECTRICAL CONNECTION</b>	1Ø - 2W, 2Ø - 3W, 3Ø - 3W, 3Ø - 4W	
<b>RATED INPUT VOLTAGE</b>	11 to 300V AC (L - N), 19 to 519V AC (L - L)	
<b>RATED INPUT CURRENT</b>	Nominal 5A (Min - 20mA, Max - 6A)	Nominal 5A (Min - 30mA ; Max - 6A)
<b>RESOLUTION</b>	Current & Voltage : Depending on CT & PT primary setting, RPM : 0.1, Run hour : 0.1hr	
<b>ACCURACY</b>	Voltage (L - N / L - L / Average) : ± 0.5% of F.S. ± 2 digits, Current & Average Current : ± 1% of F.S. ± 2 digits, Run hour : ± 1%, RPM : ± 0.5%, Frequency : ± 0.1 Hz ± 1 digit	
<b>CT PRIMARY</b>	5A to 10kA (Programmable for any value)	
<b>CT SECONDARY</b>	5A fix	
<b>PT PRIMARY</b>	100V to 500kV (Programmable for any value)	
<b>PT SECONDARY</b>	100 to 500V AC (L - L) (Programmable for any value)	
<b>MEASURING PARAMETERS</b>	Voltage (L - L / L - N) (Individual / Average), Current (Individual / Average), Frequency	
<b>ADDITIONAL FUNCTIONS</b>	Run Hour, RPM	
<b>SUPPLY VOLTAGE (AC : 50 / 60 Hz)</b>	230V AC ±20%	

## Digital Voltmeter

## Digital Ammeter

## Multifunction DPM



**MV35**  
96(H) x 96(W) x 50(D)mm



**MA32**  
96(H) x 96(W) x 50(D)mm



**MX300**  
96(H) x 96(W) x 50(D)mm

<b>FEATURES</b>	<ul style="list-style-type: none"> <li>• 1Ø &amp; 3Ø True RMS measurement</li> <li>• Wide auxiliary supply from 40 to 300V AC/DC</li> <li>• PT Primary programmable up to 999.0kV</li> <li>• K LED for kilo indication</li> </ul>	<ul style="list-style-type: none"> <li>• 1Ø &amp; 3Ø True RMS measurement</li> <li>• Wide auxiliary supply from 40 to 300V AC/DC</li> <li>• CT Primary programmable up to 999.0kA</li> <li>• K LED for kilo indication</li> </ul>	<ul style="list-style-type: none"> <li>• True RMS measurement</li> <li>• Voltage, Current, Power, Power factor, Frequency</li> <li>• Programmable CT &amp; PT</li> <li>• Communication and Relay output (applicable only for MX300-1-C-CE)</li> </ul>
<b>DISPLAY</b>	7 segment LED		
<b>DIGITS</b>	1 row of 4 digits		
<b>ELECTRICAL CONNECTION</b>	1Ø - 2W, 3Ø - 3W, 3Ø - 4W		1Ø - 2W
<b>RATED INPUT VOLTAGE</b>	11 to 300V AC (L - N), 19 to 516V AC (L - L)	---	20 - 300V AC (L - N), 34 - 519V AC (L - L)
<b>RATED INPUT CURRENT</b>	---	5A AC (Min - 50mA ; Max - 6.2A)	Nominal 5A AC (Min- 40mA, Max- 6A)
<b>RESOLUTION</b>	Auto resolution depend upon PT ratio	Auto resolution depend upon CT ratio	
<b>ACCURACY</b>	± 0.5% of F.S.		
<b>CT PRIMARY</b>	---	1 / 5A to 999.0kA (Programmable for any value)	5A - 9999A (Programmable for any value)
<b>CT SECONDARY</b>	---	1 / 5A (Programmable)	5A fix
<b>PT PRIMARY</b>	100 to 999kV (Programmable for any value)	---	100V to 500kV (Programmable for any value)
<b>PT SECONDARY</b>	100 to 500V (Programmable for any value)	---	100V to 500V AC (Programmable for any value)
<b>SUPPLY VOLTAGE</b>	40 to 300V AC / DC		85 to 300V AC / DC



## Digital Voltmeters



**MV15**  
48(H) x 96(W) x 50(D)mm



**MV205**  
72(H) x 72(W) x 50(D)mm



**MV305**  
96(H) x 96(W) x 46(D)mm



**MV334-230V**  
96(H) x 96(W) x 50(D)mm

<b>FEATURES</b>	<ul style="list-style-type: none"> <li>• True RMS measurement</li> <li>• For 1Ø - 2 wire electrical network</li> </ul>	<ul style="list-style-type: none"> <li>• True RMS measurement</li> <li>• For 1Ø - 2 wire, 3Ø - 3 wire, 3Ø - 4 wire electrical network</li> <li>• Programmable PT primary &amp; secondary</li> </ul>
<b>DISPLAY</b>	7 segment LED	
<b>DIGITS</b>	1 row of 3 digits	1 row of 4 digits
<b>ELECTRICAL CONNECTION</b>	1Ø - 2W	1Ø - 2W, 3Ø - 3W, 3Ø - 4W
<b>RATED INPUT VOLTAGE</b>	50 to 480V AC (516V max)	11 to 300V AC (L - N), 19 to 516V AC (L - L)
<b>RESOLUTION</b>	1V	Auto resolution
<b>ACCURACY</b>	± 0.5% of F.S.	± 0.5% of F. S.
<b>PT PRIMARY</b>	---	100V - 999kV
<b>PT SECONDARY</b>	---	100V - 500V
<b>SUPPLY VOLTAGE</b> (AC : 50 / 60 Hz)	240V AC ±20%	230V AC ±20%

## Digital Ammeters



**MA12** 48(H) x 96(W) x 50(D)mm  
**MA202** 72(H) x 72(W) x 50(D)mm  
**MA302** 96(H) x 96(W) x 46(D)mm



**MA12-75mV-DC** 48(H) x 96(W) x 50(D)mm  
**MA12-20A-AC** 48(H) x 96(W) x 50(D)mm



**MA335-230V AC**  
96(H) x 96(W) x 50(D)mm

<b>FEATURES</b>	<ul style="list-style-type: none"> <li>• True RMS measurement</li> <li>• For 1Ø - 2 wire electrical network</li> <li>• Programmable CT primary up to 4000A</li> </ul>	<ul style="list-style-type: none"> <li>• True RMS measurement</li> <li>• For 1Ø - 2 wire electrical network</li> </ul>	<ul style="list-style-type: none"> <li>• True RMS measurement</li> <li>• For 1Ø - 2 wire, 3Ø - 3 wire, 3Ø - 4 wire electrical network</li> <li>• Programmable CT primary &amp; secondary</li> </ul>
<b>DISPLAY</b>	7 segment LED		
<b>DIGITS</b>	1 row of 4 digits		
<b>ELECTRICAL CONNECTION</b>	1Ø - 2W		1Ø - 2W, 3Ø - 3W, 3Ø - 4W
<b>INPUT TYPE</b>	CT	Shunt	Direct
<b>RATED INPUT CURRENT</b>	5A AC (Min - 50mA ; Max - 6.2A)	0 to 75mV DC	20A Direct
<b>RESOLUTION</b>	0.001, 0.01, 0.1, 1A (Depending upon CT primary settings)	0.001, 0.01, 0.1, 1A (Depending upon shunt settings)	0.001, 0.01, 0.1, 1A
<b>ACCURACY</b>	± 0.5% of F.S.		
<b>CT PRIMARY / SHUNT SETTING</b>	5 to 4000A (Programmable in steps)	---	1 to 999.0kA (Programmable for any value)
<b>CT SECONDARY</b>	5A fix	---	1 / 5A (Programmable)
<b>SUPPLY VOLTAGE</b> (AC : 50 / 60 Hz)	240V AC ±20%		230V AC ±20%

## Digital Ammeters

## Digital Voltmeters



**MA501**  
48(H) x 48(W) x 68.5(D)mm



**MA2301**  
72(H) x 72(W) x 50(D)mm



**MV507**  
48(H) x 48(W) x 68.5(D)mm



**MV2307**  
72(H) x 72(W) x 50(D)mm

<b>FEATURES</b>	<ul style="list-style-type: none"> <li>• True RMS measurement</li> <li>• Bar graph for current representation</li> <li>• CT primary programmable up to 5000A</li> </ul>	<ul style="list-style-type: none"> <li>• True RMS measurement</li> <li>• Bar graph for current representation</li> <li>• CT primary programmable up to 5000A</li> <li>• Selector switch for page selection</li> </ul>	<ul style="list-style-type: none"> <li>• True RMS measurement</li> <li>• Bar graph for voltage representation</li> </ul>	<ul style="list-style-type: none"> <li>• True RMS measurement</li> <li>• Bar graph for voltage representation</li> <li>• Selector switch for page selection</li> </ul>
<b>DISPLAY</b>	LCD with backlight			
<b>DIGITS</b>	1 row of 4 digits		1 row of 3 digits	
<b>ELECTRICAL CONNECTION</b>	1Ø - 2W	3Ø - 4W	1Ø - 2W	3Ø - 3W, 3Ø - 4W
<b>RATED INPUT VOLTAGE</b>	---		50 to 480V AC (Max : 516V)	
<b>RATED INPUT CURRENT</b>	5AAC (Min - 50mA; Max - 6.2A)		---	
<b>RESOLUTION</b>	0.001, 0.01, 0.1, 1A (Depending on CT primary settings)		1V	
<b>ACCURACY</b>	± 0.5% of F.S.			
<b>CT PRIMARY</b>	5 to 5000A (Programmable in steps)		---	
<b>CT SECONDARY</b>	5A fix		---	
<b>SUPPLY VOLTAGE</b> (AC : 50 / 60 Hz)	240V AC ±20%			

## Voltage Ampere Meters



**MVA591-30A**  
48(H) x 48(W) x 68.5(D)mm



**MVA591-80A**  
48(H) x 48(W) x 68.5(D)mm



**MVA593**  
48(H) x 48(W) x 79(D)mm

<b>FEATURES</b>	<ul style="list-style-type: none"> <li>• True RMS measurement</li> <li>• 3 Digit 7 segment dual line display</li> <li>• Direct 30A &amp; 80A measurement with Hanging CT</li> </ul>	<ul style="list-style-type: none"> <li>• True RMS measurement</li> <li>• Measure 1Ø &amp; 3Ø voltage and current</li> <li>• 3 digit 7 segment dual line display</li> <li>• Works with 1 phase and 3 phase CT</li> </ul>
<b>DISPLAY PARAMETERS</b>	Voltage & Current	
<b>DISPLAY</b>	3 digits 7 segment LED display with dual rows	
<b>COLOUR</b>	Red and Green	
<b>ELECTRICAL CONNECTION</b>	1Ø - 2W	1Ø - 2W, 3Ø - 3W, 3Ø - 4W
<b>RESOLUTION</b>	Voltage : 1V; Current : 0.1A	For Current <10A : 0.01A, <100A : 0.1A, >100A : 1A For Voltage <100V : 0.1V, >100V : 1V
<b>RATED INPUT VOLTAGE</b>	230V AC (± 20%)	
<b>RATED INPUT CURRENT</b>	1 to 30A	4 to 80A
<b>OPERATING FREQUENCY</b>	50Hz (±5%)	
<b>CURRENT OVERLOAD</b>	36A	96A
<b>ACCURACY</b>	±1% full scale	
<b>SUPPLY VOLTAGE</b>	230V AC, ±20%	

## MVA593 Accessories



**CT 3PH-D13MM-80A-G**



**CT 3PH-21X25MM-250A-G**



**CT 1PH-D13MM-80A-G**



**CT 1PH-30X10MM-250A-G**



**3PH 5A CONVERTER-G**

<b>RATED INPUT CURRENT</b>	Nominal 80A AC (Min 4A - Max 96A)	Nominal 250A AC (Min 10A - Max 300A)	Nominal 80A AC (Min 4A - Max 96A)	Nominal 250A AC (Min 10A - Max 300A)	Nominal 5A AC (Min 50mA - Max 6A)
<b>NO. OF PHASES</b>	3		1		3
<b>INNER DIA</b>	13mm	21x 25mm	13mm	30x10mm	4.85mm
<b>MOUNTING</b>	Din rail & Wall mount				



**AM - V**  
72(H) x 72(W) x 60(D)mm /  
96(H) x 96(W) x 60(D)mm



**AM - I**  
72(H) x 72(W) x 60(D)mm /  
96(H) x 96(W) x 60(D)mm



**AM - Direct Type Ammeter**  
72(H) x 72(W) x 60(D)mm /  
96(H) x 96(W) x 60(D)mm



**AM - Power Factor**  
72(H) x 72(W) x 60(D)mm /  
96(H) x 96(W) x 60(D)mm



**AM - Frequency**  
72(H) x 72(W) x 60(D)mm /  
96(H) x 96(W) x 60(D)mm

FEATURES	<ul style="list-style-type: none"> <li>• True RMS (Voltage) measurement</li> <li>• Scale inter changeability</li> <li>• Non linear scale</li> <li>• Easy installation / termination</li> </ul>	<ul style="list-style-type: none"> <li>• True RMS (Current) measurement</li> <li>• Scale inter changeability</li> <li>• Non linear scale</li> <li>• Easy installation / termination</li> </ul>	<ul style="list-style-type: none"> <li>• True RMS (Current) measurement</li> <li>• Non linear scale</li> <li>• Easy installation / termination</li> </ul>	<ul style="list-style-type: none"> <li>• Non linear scale</li> <li>• Easy installation / termination</li> </ul>	<ul style="list-style-type: none"> <li>• Linear scale</li> <li>• Easy installation / termination</li> </ul>
MEASURING PARAMETERS	AC Voltage	AC Current	Direct meter	Power factor	Frequency
POINTER DEFLECTION	0 to 90°			45° - 0° - 45°	0 to 90°
SCALE CHARACTERISTICS	Non linear				Linear
SCALE LENGTH	72 x 72mm: 63 mm / 96 x 96mm: 97 mm				
MEASURING RANGE	0 to 300V / 500V	0 to 5A (CT Secondary), Suppress scale :0 to 5 / 30A (CT Secondary)	10 to 100A	0.5CAP - 1 - 0.5IND	45 - 65Hz
ACCURACY	Class 1.5				Class 1.0
FREQUENCY	50 / 60Hz				---



Square



Split Core



Round



Tape Wound

FEATURES	<ul style="list-style-type: none"> <li>• Use with different bus bar size</li> <li>• Panel / DIN rail mount (Require optional accessory)</li> <li>• Accuracy : Class 0.5 to 5</li> </ul>	<ul style="list-style-type: none"> <li>• Nominal rating ranges from 100A to 6000A</li> <li>• Snap closing / opening feature</li> <li>• Mounting types : Base, Busbar &amp; Wall mount</li> </ul>	<ul style="list-style-type: none"> <li>• Sealable terminal / Wire type output</li> <li>• Panel mount</li> <li>• Accuracy : Class 1 to 5</li> </ul>	<ul style="list-style-type: none"> <li>• Terminal output</li> <li>• Accuracy : Class 0.5 to 5</li> </ul>
RATED PRIMARY RATING	30 to 4000A	10 to 6000A	30 to 600A	30 to 1600A
RATED SECONDARY OUTPUT	5A			
RATED BURDEN (VA)	1,1.25, 1.5, 2.5, 3, 3.75, 5, 7.5, 10, 15	1,1.5, 2.5, 3, 5, 7.5, 10, 15	1.5, 5	1.5, 5, 10
ACCURACY	0.5, 1, 3, 5	0.5, 1, 3	1, 5	0.5, 1, 5
OPERATING FREQUENCY	AC 50 / 60Hz			
SYSTEM VOLTAGE	720V max			
APPLICABLE STANDARD	IEC 61869-2			

## Ordering information

### Multifunction Meters

PRODUCT CODE	SUPPLY VOLTAGE	OUTPUT		CERTIFICATION
		PULSE OUTPUT	COMM. (RS485)	
MFM384-C-CU	85 to 300V AC	YES	YES	CE
MFM384-C-CE *	85 to 300V AC / DC	YES	YES	CE
MFM384-C-CE-CL05	85 to 300V AC / DC	YES	YES	CE
MFM384-C-D-CE-CL05-PLUS	40 to 300V AC / DC	YES	YES	CE
MFM384-R-C-CE *	85 to 270V AC	YES	YES	CE
MFM284-C-CE	85 to 270V AC	YES	YES	CE
MFM383A	85 to 270V AC	YES	---	---
MFM383A-C-CE	85 to 270V AC	YES	YES	CE

### Multifunction Meters

PRODUCT CODE	SUPPLY VOLTAGE	OUTPUT		CERTIFICATION
		PULSE OUTPUT	COMM. (RS485)	
MFM376-CE	40 to 300V AC / DC	YES	---	CE
MFM376-C-CE	40 to 300V AC / DC	YES	YES	CE
MFM376-C-D-CE-CL05-PLUS	40 to 300V AC / DC	---	YES	CE
MFM376-C-CE-PLUS	40 to 300V AC / DC	YES	YES	CE
MFM391	85 to 270V AC	---	---	CE Optional

NOTE : \* MID variants available

## Ordering information

### Multifunction Meters

PRODUCT CODE	SUPPLY VOLTAGE	OUTPUT		CERTIFICATION
		PULSE OUTPUT	COMMN. (RS485)	
MRJ4M *	Self powered (V1, N), 60 to 300V AC	YES	YES	CE
MRJ4M-SL *	Self powered (V1, N), 60 to 300V AC	YES	YES	CE
MRJ385-G-PNW *	Self powered (V1, N), 100V to 240V AC	YES	YES	CE
MRJ4M-QUAD	Self powered (V1, N), 60 to 300V AC	---	YES	CE

### Current Transformers

PRODUCT CODE	PRIMARY	OUTPUT	CERTIFICATION
PWCT-15/30-60A/330mV	60A	330mV	CE
PWCT-15/30-100A/330mV	100A	330mV	CE
PWCT-15/30-125A/330mV	125A	330mV	CE
PWCT-15/30-160A/330mV	160A	330mV	CE
PWCT-16/20-60A/330mV	60A	330mV	CE
PWCT-16/20-100A/330mV	100A	330mV	CE
PWCT-16/20-125A/330mV	125A	330mV	CE
PWCT-16/20-160A/330mV	160A	330mV	CE
PWCT-16/20-200A/330mV	200A	330mV	CE
PWCT-21/25-60A/330mV	60A	330mV	CE
PWCT-21/25-100A/330mV	100A	330mV	CE
PWCT-21/25-125A/330mV	125A	330mV	CE
PWCT-21/25-160A/330mV	160A	330mV	CE
PWCT-21/25-200A/330mV	200A	330mV	CE
PWCT-21/25-250A/330mV	250A	330mV	CE
PWCT-31/31-250A/330mV	250A	330mV	CE
PWCT-31/31-300A/330mV	300A	330mV	CE
PWCT-31/31-400A/330mV	400A	330mV	CE
PWCT-31/31-500A/330mV	500A	330mV	CE
PWCT-31/31-600A/330mV	600A	330mV	CE
PWCT-31/31-630A/330mV	630A	330mV	CE
PWCT-54/50-800A/330mV	800A	330mV	CE
PWCT-54/50-1000A/330mV	1000A	330mV	CE
PWCT-54/50-1250A/330mV	1250A	330mV	CE
PWCT-54/50-1600A/330mV	1600A	330mV	CE

### Plug-N-Wire Accessories

PRODUCT CODE	DESCRIPTION
PWCBL_CON-F-1	Power cable with Female type connector, 1 Meter length
PWCBL_CON-F-3	Power cable with Female type connector, 3 Meter length
PWCBL_CON-M/F-1	Daisy chain cable to loop MRJ meters with Male & Female type connectors, 1 Meter length
PWCBL_CON-M/F-3	Daisy chain cable to loop MRJ meters with Male & Female type connectors, 3 Meter length
PWCON-M	Voltage connector Male
PWCON-F	Voltage connector Female
CTV Converter 1A/330mV	Converter used with PLCTs for MRJ multifunction meter series
PWADP-5A	5A adapter to use with conventional CT for MRJ4M, MRJ4M-SL & MRJ385-G-PNW
PWADP-1A	1A adapter to use with conventional CT for MRJ4M-QUAD meter

### Energy Meter - DC

PRODUCT CODE	SUPPLY VOLTAGE	OUTPUT	CERTIFICATION
EM2M-1CH-C-DC-1RO-CE	18 to 30V DC	Relay Output	CE
EM2M-1CH-C-DC-DL-CE	18 to 30V DC	Data Logging	CE

### Energy Meters

PRODUCT CODE	SUPPLY VOLTAGE	OUTPUT		CERTIFICATION
		PULSE OUTPUT	COMMN.	
EM306	85 to 276V AC	YES	RS485	---
EM306-C-D	85 to 276V AC	---	RS485	---
EM368-C-CU	85 to 276V AC	YES	RS485	CE
EM2M-1P-C-100A *	176 to 276V AC (Self powered)	YES	RS485	CE
EM2M-1P-W-100A	176 to 276V AC (Self powered)	---	Wi-Fi	CE
EM4M-3P-C-100A	85 to 285V AC (L-N), 150 to 494V AC (L-L)	YES	RS485	CE
EM4M-3P-W-100A	85 to 285V AC (L-N), 150 to 494V AC (L-L)	YES	Wi-Fi	CE

### Voltage Ampere Frequency Meters

PRODUCT CODE	SUPPLY VOLTAGE	CERTIFICATION
VAF36A-230-CE	230V AC, ±20%	CE
VAF39A-1-230V	230V AC, ±20%	---
VAF39A-1-230V-CE	230V AC, ±20%	CE
VAF39A-1-60V DC	20 to 60V DC	---

### Voltage Ampere Meters

PRODUCT CODE	SUPPLY VOLTAGE	CERTIFICATION
MVA591-30A-230V	230V AC, ±20%	---
MVA591-80A-230V	230V AC, ±20%	---
MVA593-CE	85 to 276V AC	CE

### LCD (Ammeters / Voltmeters)

PRODUCT CODE	SUPPLY VOLTAGE	CERTIFICATION
MV35-3-G-40/300V-CE	40 to 300V AC / DC	CE
MV35-1-G-40/300V-CE	40 to 300V AC / DC	CE
MA32-3-G-40/300V-CE	40 to 300V AC / DC	CE
MA32-1-G-40/300V-CE	40 to 300V AC / DC	CE
MX300-CE	85 to 300V AC	CE
MX300-1-C-CE	85 to 300V AC	CE

### LED (Voltmeters)

PRODUCT CODE	SUPPLY VOLTAGE	CERTIFICATION
MV15	240V AC, ±20%	---
MV15-CE	240V AC, ±20%	CE
MV205	240V AC, ±20%	---
MV205-CE	240V AC, ±20%	CE
MV305	240V AC, ±20%	---
MV305-CE	240V AC, ±20%	CE
MV334-230V	230V AC, ±20%	---
MV334-230V-CE	230V AC, ±20%	CE

### LED (Ammeters)

PRODUCT CODE	SUPPLY VOLTAGE	CERTIFICATION
MA12	240V AC, ±20%	---
MA12-CE	240V AC, ±20%	CE
MA12-20A-AC	240V AC, ±20%	---
MA202	240V AC, ±20%	---
MA202-CE	240V AC, ±20%	CE
MA302	240V AC, ±20%	---
MA302-CE	240V AC, ±20%	CE
MA335-230VAC	230V AC, ±20%	---
MA335-230VAC-CE	230V AC, ±20%	CE
MA12-75mV-DC	230V AC, ±20%	---

NOTE : \* MID variants available, Additional Accessories on page 53

## Ordering information

### LCD (Ammeters / Voltmeters)

PRODUCT CODE	SUPPLY VOLTAGE	CERTIFICATION
MA501-230V-CE	240V AC, ±20%	CE
MA501-CU	240V AC, ±20%	CE
MA2301-230V-CE	240V AC, ±20%	CE
MV507-230V-CE	240V AC, ±20%	CE
MV2307-230V-CE	240V AC, ±20%	CE

### MVA593 Accessories

PRODUCT CODE	CURRENT RANGE	CERTIFICATION
CT 1PH-D13MM-80A-G	80A	CE
CT 1PH-30X10MM-250A-G	250A	CE
CT 3PH-D13MM-80A-G	80A	CE
CT 3PH-21X25MM-250A-G	250A	CE
3PH 5A CONVERTER-G	800A	CE

### Analog Voltmeters

PRODUCT CODE	CERTIFICATION	AM - V - 2 - N
AM-V-2-N-CE-RoHS	CE	<p>(Input voltage) N : 300V; L : 500V</p> <p>(Size) 2 : 72 x 72mm, 3 : 96 x 96mm</p> <p>(Series) Voltmeter</p> <p>(Category) Analog meter</p>
AM-V-3-N-CE-RoHS	CE	
AM-V-2-L-CE-RoHS	CE	
AM-V-3-L-CE-RoHS	CE	
AM-V-2-N	---	
AM-V-3-N	---	
AM-V-2-L	---	
AM-V-3-L	---	

### Analog Ammeters

PRODUCT CODE (Meters without dial plates)	CERTIFICATION	AM - I - 2 - 5A - 6S - WD
AM-I-2-5A-WD-CE-RoHS	CE	<p>Without dial plate</p> <p>6 times suppress</p> <p>Secondary current</p> <p>(Size) 2 : 72 x 72mm, 3 : 96 x 96mm</p> <p>(Series) Ammeter</p> <p>(Category) Analog meter</p>
AM-I-2-5A-6S-WD-CE-RoHS	CE	
AM-I-3-5A-WD-CE-RoHS	CE	
AM-I-3-5A-6S-WD-CE-RoHS	CE	
AM-I-2-5A-WD	---	
AM-I-2-5A-6S-WD	---	
AM-I-3-5A-WD	---	
AM-I-3-5A-6S-WD	---	

### Analog Ammeters

PRODUCT CODE (Meters without dial plates)	CERTIFICATION	SCL - AM - I - 2 - X / 5A - 6S
SCL-AM-I-2-X/5A	---	<p>6 times suppress</p> <p>Secondary current</p> <p>Primary current (30A to 4000A)</p> <p>(Size) 2 : 72 x 72mm, 3 : 96 x 96mm</p> <p>(Series) Ammeter</p> <p>(Category) Analog meter</p> <p>Scale plate</p>
SCL-AM-I-3-X/5A	---	
SCL-AM-I-2-X/5A-6S	---	
SCL-AM-I-3-X/5A-6S	---	

### Analog Direct Type Ammeters

PRODUCT CODE	CERTIFICATION	AM - I - D - 2 - X
AM-I-D-2-X-CE-RoHS	CE	<p>Display scale X: 10A to 100A</p> <p>(Size) 2 : 72x72mm, 3: 96 x 96mm</p> <p>Direct type</p> <p>(Series) Ammeter</p> <p>(Category) Analog meter</p>
AM-I-D-3-X-CE-RoHS	CE	
AM-I-D-2-X	---	
AM-I-D-3-X	---	

### Analog Frequency Meters

PRODUCT CODE	CERTIFICATION	AM - Hz - 3 - A - B
AM-Hz-3-A-B-CE-RoHS	CE	<p>(Voltage range) B: 220V, 440V</p> <p>(Frequency range) A: 45 - 65Hz</p> <p>(Size) 2 : 72 x 72mm, 3: 96 x 96mm</p> <p>(Series) Frequency</p> <p>(Product name) Analog meter</p>
AM-Hz-2-A-B-CE-RoHS	CE	
AM-Hz-3-A-B	---	
AM-Hz-2-A-B	---	

### Analog Power Factor Meters

PRODUCT CODE	CERTIFICATION
AM-PF-3-3P1E-0.5CAP-1-0.5IND-X-5A-CE-RoHS	CE
AM-PF-2-3P1E-0.5CAP-1-0.5IND-X-5A-CE-RoHS	CE
AM-PF-3-3P1E-0.5CAP-1-0.5IND-X-5A	---
AM-PF-2-3P1E-0.5CAP-1-0.5IND-X-5A	---

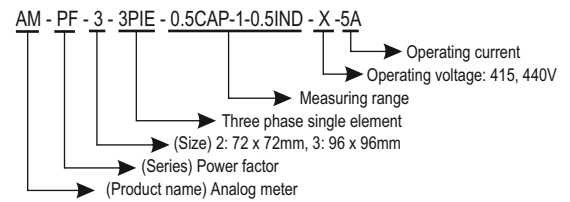

### RCT



































PRODUCT CODE	WIRE APERTURE In mm	CURRENT RATIO	BURDEN IN VA	ACCURACY CLASS	NO. OF PRIMARY TURNS
RCT-T-D30-30/5A-VA1.5-CL5	DIA 30	30/5	1.5	5	---
RCT-T-D30-30/5A-VA5-(2T)-CL5	DIA 30	30/5	5	5	2
RCT-T-D30-50/5A-VA5-CL5	DIA 30	50/5	5	5	---
RCT-T-D30-75/5A-VA5-CL5	DIA 30	75/5	5	5	---
RCT-T-D30-100/5A-VA5-CL1	DIA 30	100/5	5	1	---
RCT-T-D30-150/5A-VA5-CL1	DIA 30	150/5	5	1	---
RCT-T-D50-200/5A-VA5-CL1	DIA 50	200/5	5	1	---
RCT-T-D50-250/5A-VA5-CL1	DIA 50	250/5	5	1	---
RCT-T-D50-300/5A-VA5-CL1	DIA 50	300/5	5	1	---
RCT-T-D50-400/5A-VA5-CL1	DIA 50	400/5	5	1	---
RCT-T-D50-500/5A-VA5-CL1	DIA 50	500/5	5	1	---
RCT-T-D50-600/5A-VA5-CL1	DIA 50	600/5	5	1	---

### TWCT

PRODUCT CODE	WIRE APERTURE In mm	CURRENT RATIO	BURDEN IN VA	ACCURACY CLASS
TWCT-T-D35-30/5A-VA1.5-CL5	DIA 35	30/5	1.5	5
TWCT-T-D35-50/5A-VA5-CL5	DIA 35	50/5	5	5
TWCT-T-D35-75/5A-VA5-CL5	DIA 35	75/5	5	5
TWCT-T-D35-100/5A-VA5-CL1	DIA 35	100/5	5	1
TWCT-T-D35-150/5A-VA5-CL1	DIA 35	150/5	5	1
TWCT-T-D55-150/5A-VA5-CL1	DIA 55	150/5	5	1
TWCT-T-D55-200/5A-VA5-CL1	DIA 55	200/5	5	1
TWCT-T-D55-250/5A-VA5-CL1	DIA55	250/5	5	1
TWCT-T-D55-300/5A-VA5-CL1	DIA 55	300/5	5	1
TWCT-T-D55-400/5A-VA5-CL1	DIA 55	400/5	5	1
TWCT-T-D65-500/5A-VA5-CL1	DIA 65	500/5	5	1
TWCT-T-D65-600/5A-VA5-CL1	DIA 65	600/5	5	1
TWCT-T-D110-800/5A-VA10-CL0.5	DIA 110	800/5	10	0.5
TWCT-T-D110-1000/5A-VA10-CL0.5	DIA 110	1000/5	10	0.5
TWCT-T-D120-1000/5A-VA10-CL0.5	DIA 120	1000/5	10	0.5
TWCT-T-D120-1200/5A-VA10-CL0.5	DIA 120	1200/5	10	0.5
TWCT-T-D120-1600/5A-VA10-CL0.5	DIA 120	1600/5	10	0.5

## Ordering information

### SPCT

PRODUCT CODE	WIRE APERTURE In mm	CURRENT RATIO	BURDEN IN VA	ACCURACY CLASS	CERTIFICATION
SPCT-50/30-60/5A-VA1-CL5	30x10	60 / 5	1	5	CE 
SPCT-50/30-75/5A-VA1-CL1	30x10	75 / 5	1	1	CE 
SPCT-50/30-80/5A-VA1-CL1	30x10	80 / 5	1	1	CE 
SPCT-50/30-100/5A-VA1-CL1	30x10	100 / 5	1	1	CE 
SPCT-50/30-125/5A-VA1.25-CL1	30x10	125 / 5	1.25	1	CE 
SPCT-50/30-160/5A-VA1.5-CL1	30x10	160 / 5	1.5	1	CE 
SPCT-50/30-200/5A-VA3-CL1	30x10	200 / 5	3	1	CE 
SPCT-50/30-250/5A-VA3-CL1	30x10	250 / 5	3	1	CE 
SPCT-50/30-400/5A-VA5-CL1	30x10	400 / 5	5	1	CE 
SPCT-62/22-30/5A-VA1-CL5	DIA 22	30/5	1	5	CE 
SPCT-62/30-50/5A-VA1-CL3	30x10	50/5	1	3	CE 
SPCT-62/30-50/5A-VA1.5-CL3	30x10	50/5	1.5	3	CE 
SPCT-62/30-75/5A-VA1-CL3	30x10	75/5	1	3	CE 
SPCT-62/30-75/5A-VA3-CL3	30x10	75/5	3	3	CE 
SPCT-62/30-100/5A-VA1-CL1	30x10	100/5	1	1	CE 
SPCT-62/30-100/5A-VA3-CL1	30x10	100/5	3	1	CE 
SPCT-62/40-100/5A-VA1-CL1	40x10	100/5	1	1	CE 
SPCT-62/40-125/5A-VA1-CL1	40x10	125/5	1	1	CE 
SPCT-62/40-150/5A-VA1.5-CL1	40x10	150/5	1.5	1	CE 
SPCT-62/40-150/5A-VA3-CL1	40x10	150/5	3	1	CE 
SPCT-62/40-160/5A-VA1.5-CL1	40x10	160/5	1.5	1	CE 
SPCT-62/40-200/5A-VA2.5-CL0.5	40x10	200/5	2.5	0.5	CE 
SPCT-62/40-200/5A-VA3-CL1	40x10	200/5	3	1	CE 
SPCT-62/40-250/5A-VA2.5-CL0.5	40x10	250/5	2.5	0.5	CE 
SPCT-62/40-250/5A-VA3-CL1	40x10	250/5	3	1	CE 
SPCT-62/40-300/5A-VA3-CL0.5	40x10	300/5	3	0.5	CE 
SPCT-62/40-400/5A-VA3.75-CL0.5	40x10	400/5	3.75	0.5	CE 
SPCT-62/40-400/5A-VA5-CL1	40x10	400/5	5	1	CE 
SPCT-100/60-500/5A-VA5-CL1	60x12	500/5	5	1	CE 
SPCT-100/60-600/5A-VA5-CL0.5	60x12	600/5	5	0.5	CE 
SPCT-100/60-600/5A-VA7.5-CL1	60x12	600/5	7.5	1	CE 
SPCT-100/60-800/5A-VA10-CL0.5	60x12	800/5	10	0.5	CE 
SPCT-100/60-1000/5A-VA15-CL0.5	60x12	1000/5	15	0.5	CE 
SPCT-100/60-1200/5A-VA15-CL0.5	60x12	1200/5	15	0.5	CE 
SPCT-140/100-800/5A-VA15-CL0.5	100x30	800/5	15	0.5	CE
SPCT-140/100-1000/5A-VA15-CL0.5	100x30	1000/5	15	0.5	CE
SPCT-140/100-1200/5A-VA15-CL0.5	100x30	1200/5	15	0.5	CE
SPCT-140/100-1250/5A-VA15-CL0.5	100x30	1250/5	15	0.5	CE
SPCT-140/100-1500/5A-VA15-CL0.5	100x30	1500/5	15	0.5	CE
SPCT-140/100-1600/5A-VA15-CL0.5	100x30	1600/5	15	0.5	CE
SPCT-140/100-2000/5A-VA15-CL0.5	100x30	2000/5	15	0.5	CE
SPCT-140/100-2500/5A-VA15-CL0.5	100x30	2500/5	15	0.5	CE
SPCT-140/100-3000/5A-VA15-CL0.5	100x30	3000/5	15	0.5	CE
SPCT-140/100-3500/5A-VA15-CL0.5	100x30	3500/5	15	0.5	CE
SPCT-140/100-4000/5A-VA15-CL0.5	100x30	4000/5	15	0.5	CE

### SCCT

PRODUCT CODE	APERTURE In mm	CURRENT RATIO	BURDEN IN VA	ACCURACY CLASS	CERTIFICATION
SCCT-30/20-100/5A-VA1-CL1-CE	20x30	100/5A	1	1	CE
SCCT-30/20-100/5A-VA1.5-CL3-CE	20x30	100/5A	1.5	3	CE
SCCT-30/20-150/5A-VA1-CL0.5-CE	20x30	150/5A	1	0.5	CE
SCCT-30/20-150/5A-VA1.5-CL3-CE	20x30	150/5A	1.5	3	CE
SCCT-30/20-200/5A-VA1-CL0.5-CE	20x30	200/5A	1	0.5	CE
SCCT-30/20-200/5A-VA1.5-CL1-CE	20x30	200/5A	1.5	1	CE
SCCT-30/20-250/5A-VA1.5-CL0.5-CE	20x30	250/5A	1.5	0.5	CE
SCCT-30/20-300/5A-VA2.5-CL0.5-CE	20x30	300/5A	2.5	0.5	CE
SCCT-30/20-400/5A-VA2.5-CL0.5-CE	20x30	400/5A	2.5	0.5	CE
SCCT-80/50-250/5A-VA1.5-CL1-CE	50x80	250/5A	1.5	1	CE
SCCT-80/50-300/5A-VA1.5-CL1-CE	50x80	300/5A	1.5	1	CE
SCCT-80/50-400/5A-VA1.5-CL0.5-CE	50x80	400/5A	1.5	0.5	CE
SCCT-80/50-500/5A-VA2.5-CL0.5-CE	50x80	500/5A	2.5	0.5	CE
SCCT-80/50-600/5A-VA2.5-CL0.5-CE	50x80	600/5A	2.5	0.5	CE
SCCT-80/50-750/5A-VA2.5-CL0.5-CE	50x80	750/5A	2.5	0.5	CE
SCCT-80/50-800/5A-VA2.5-CL0.5-CE	50x80	800/5A	2.5	0.5	CE
SCCT-80/50-1000/5A-VA5-CL0.5-CE	50x80	1000/5A	5	0.5	CE
SCCT-120/80-500/5A-VA2.5-CL0.5-CE	80x120	500/5A	2.5	0.5	CE
SCCT-120/80-600/5A-VA2.5-CL0.5-CE	80x120	600/5A	2.5	0.5	CE
SCCT-120/80-750/5A-VA2.5-CL0.5-CE	80x120	750/5A	2.5	0.5	CE
SCCT-120/80-800/5A-VA2.5-CL0.5-CE	80x120	800/5A	2.5	0.5	CE
SCCT-120/80-1000/5A-VA5-CL0.5-CE	80x120	1000/5A	5	0.5	CE
SCCT-120/80-1200/5A-VA7.5-CL0.5-CE	80x120	1200/5A	7.5	0.5	CE
SCCT-120/80-1250/5A-VA7.5-CL0.5-CE	80x120	1250/5A	7.5	0.5	CE
SCCT-120/80-1500/5A-VA7.5-CL0.5-CE	80x120	1500/5A	7.5	0.5	CE
SCCT-120/80-1500/5A-VA10-CL1-CE	80x120	1500/5A	10	1	CE
SCCT-120/80-1600/5A-VA10-CL0.5-CE	80x120	1600/5A	10	0.5	CE
SCCT-160/80-1000/5A-VA10-CL0.5-CE	80x160	1000/5A	10	0.5	CE
SCCT-160/80-1200/5A-VA10-CL0.5-CE	80x160	1200/5A	10	0.5	CE
SCCT-160/80-1250/5A-VA10-CL0.5-CE	80x160	1200/5A	10	0.5	CE
SCCT-160/80-1500/5A-VA15-CL0.5-CE	80x160	1500/5A	15	0.5	CE
SCCT-160/80-2000/5A-VA15-CL0.5-CE	80x160	2000/5A	15	0.5	CE
SCCT-160/80-2500/5A-VA15-CL0.5-CE	80x160	2500/5A	15	0.5	CE
SCCT-160/80-3000/5A-VA15-CL0.5-CE	80x160	3000/5A	15	0.5	CE
SCCT-160/80-4000/5A-VA15-CL0.5-CE	80x160	4000/5A	15	0.5	CE
SCCT-160/80-5000/5A-VA15-CL0.5-CE	80x160	5000/5A	15	0.5	CE
SCCT-160/80-6000/5A-VA15-CL0.5-CE	80x160	6000/5A	15	0.5	CE

### SPCT Accessories

PRODUCT CODE	DESCRIPTION
AC-SPCT-DRAIL-01	Accessory - Din Rail Mounting plate for Basbar CT, Qty. 10 Nos
AC-SPCT-50/30-DRAIL-01	Accessory - Din Rail Mounting plate for 50/30 Basbar CT, Qty. 10 Nos



APFC148 : With 3 CT sensing  
144(H) x 144(W) x 50(D)mm



APFC146 : With 1 CT sensing  
144(H) x 144(W) x 50(D)mm



APFC346 : With 1 CT sensing  
96(H) x 96(W) x 55(D)mm



APFC147 : With 1 CT sensing  
144(H) x 144(W) x 50(D)mm



APFC347 : With 1 CT sensing  
96(H) x 96(W) x 55(D)mm

<b>FEATURES</b>	<ul style="list-style-type: none"> <li>• 3 CT sensing with VAF metering function built in</li> <li>• Configurable up to 12/14* stages</li> <li>• Configurable alarm settings</li> <li>• Dual Colour Backlight for indicating Normal &amp; Alarm function</li> <li>• RS485 MODBUS RTU protocol</li> </ul>	<ul style="list-style-type: none"> <li>• 1 CT sensing</li> <li>• Intelligent switching sequence</li> <li>• Configurable up to 12 stages</li> <li>• Alarm for No current, Phase current error &amp; over temperature</li> <li>• Automatic sensing of capacitor bank values</li> </ul>	<ul style="list-style-type: none"> <li>• 1 CT sensing</li> <li>• Intelligent switching sequence</li> <li>• Configurable up to 8 stages</li> <li>• Alarm for No voltage, Phase current error</li> <li>• Automatic sensing of capacitor bank values</li> </ul>	<ul style="list-style-type: none"> <li>• 1 CT sensing</li> <li>• Intelligent switching sequence</li> <li>• Configurable up to 8 &amp; 12 stages</li> <li>• Automatic sensing of capacitor bank values</li> </ul>	<ul style="list-style-type: none"> <li>• 1 CT sensing</li> <li>• Intelligent switching sequence</li> <li>• Configurable up to 8</li> <li>• Automatic sensing of capacitor bank values</li> </ul>
<b>DISPLAY</b>	LCD with dual colour backlight	LCD with backlight		7 segment LED	
<b>DIGITS</b>	3 rows, 4 digits to show electrical parameters	1 row, 4 digits to show power factor			
<b>ELECTRICAL CONNECTION</b>	1Ø - 2W, 2Ø - 2W, 3Ø - 3W, 3Ø - 4W	2Ø - 2W (L2-L3)		1Ø - 2W, 2Ø - 2W	
<b>RATED INPUT VOLTAGE</b>	100 to 300V AC (L - N), 50 to 520V AC (L - L)	50 to 520V AC (L-L)		40 to 300V AC (L - N), 50 to 520V AC (L - L)	
<b>RATED INPUT CURRENT</b>	Nominal 5AAC (Min - 11mA; Max - 6A)	Nominal 5AAC (Min 50mA, Max 6A)			
<b>POWER CONSUMPTION</b>	15VA max	7VA max	15VA max	7VA max	
<b>FREQUENCY</b>	45 to 65Hz				
<b>MEASUREMENT RANGE</b>	Power Factor : 0.8 lag to 0.8 lead				
<b>ALARM SETTINGS</b>	Over / Under voltage, Over / Under-compensation, CT polarity error, Over-temperature, Fan setting, No voltage, THDI.	Over Temperature Error, CURR : Phase current error	No Voltage Alarm, CURR : Phase current error	CT polarity error, CURR : Phase current error, No volt	
<b>PHASE COMPENSATION</b>	0°, 90°, 120°, 210°, 240°, 330°	---			
<b>ACCURACY</b>	Power factor : ± 0.01, Voltage (L-N/L-L), Current : ±0.5% of F.S., Frequency : For L-N > 20V For L-L > 35V : ±0.1% of F.S., Power (kW, kVA, kVAh) : 1%, Energy (kWh, kVAh, kVAh) : Class 1, Temperature : ±3°C of F.S.	Power factor : ±0.01, Temperature : ±3° of full scale	Power factor : ±0.01		
<b>CT PRIMARY</b>	5A to 9999A (Programmable for any value)	---	5A fix		
<b>CT SECONDARY</b>	5A fix	---	5A fix		
<b>PT PRIMARY</b>	100V to 500kV (Programmable for any value)	---			
<b>PT SECONDARY</b>	100 to 500V (Programmable for any value)	---			
<b>STEPS</b>	1 to 12 / 14* *(FAN & ALARM output can be used as 13° & 14° step)	1 to 12	1 to 8		
<b>RELAY CONTACT</b>	5A @ 250V AC				
<b>SWITCHING PROGRAM</b>	Automatic				
<b>STEP TIME</b>	1 to 999s				
<b>DISCHARGE TIME</b>	1 to 999s				
<b>CONTROL MODE</b>	Automatic / Manual				
<b>CONTROL SENSITIVITY</b>	60%	---	60%		
<b>AUTO INITIALIZATION</b>	Yes / No	Yes		Yes / No	
<b>COMMUNICATION</b>	RS485 MODBUS RTU protocol* *(Only for 12 stage variant)	---			
<b>SUPPLY VOLTAGE (AC : 50 / 60 Hz)</b>	90 to 550V AC		85 to 270V AC	90 to 550V AC	85 to 270V AC



Standard Duty Capacitor

Heavy Duty Capacitor

FEATURES	<ul style="list-style-type: none"> <li>• Protection - Over pressure disconnection system</li> <li>• Over current : HD - 1.5 times, SD - 1.3 times capacity</li> <li>• Internal fuse for protection</li> <li>• Dry type</li> <li>• Polyurethane self - extinguishing resin V0 developed under standard UL 94</li> <li>• Fire proof</li> </ul>
VOLTAGE	440, 480, 525 V
OVER VOLTAGE (HD)	1.10 x Un (8 h/day) ; 1.15 x Un (30 min/day) ; 1.20 x Un (5 min/day) ; 1.30 x Un (1 min/day) ; 1.10 x Un (8 h/day) ; 1.15 x Un (30 min/day) ; 1.20 x Un (5 min/day) ; 1.30 x Un (1 min/day)
OVER CURRENT	1.3 x In
DISCHARGE RESISTANCE	Incorporated
FREQUENCY	50 Hz
MAX %THD IN CURRENT	25
CAPACITOR TOLERANCE	-5% +10%
TYPE	Delta
DISCHARGE RESISTANCE	MOR
VOLTAGE TEST BETWEEN TERMINAL	2.15 x Un 10s
VOLTAGE TEST BETWEEN TERMINAL & CASE	3kV AC for 1 min
INRUSH CURRENT	up to 200 x In (HD)
INTERNAL FUSES	Yes
IP PROTECTION CLASS	IP 2x
DIELECTRIC LOSSES	≤ 0.2 W / kVAr
TOTAL LOSSES	≤ 0.45 W / kVAr
HUMIDITY	Max. 95%
TEMPERATURE	0 to +55°C
ALTITUDE	Max 2000 m.a.s.l
MOUNTING POSITION	Vertical





Wall Mount



Wall Mount



Rack Type

FEATURES	<ul style="list-style-type: none"> <li>• Available in 15kVAr, 50kVAr &amp; 100kVAr</li> <li>• Real time, dynamic step-less compensation</li> <li>• Instant response time of 50 μsec &amp; full response in less than 1 cycle</li> <li>• Capacitive (Leading) &amp; Inductive (Lagging) reactive power mitigation</li> <li>• Advance feature- Harmonic correction up to 15<sup>th</sup> order</li> <li>• Compensates current unbalance created by the load</li> </ul>		
SINGLE - MODULE COMPENSATION CAPACITY	15kVAr	50kVAr	100 kVAr
RATED VOLTAGE	228~456V AC	308V to 480V ±15%	
FREQUENCY	50 / 60 Hz (±2.5 Hz)		
PARALLEL OPERATION	8		
OVERALL EFFICIENCY	> 97%		
POWER GRID STRUCTURE	3P3W / 3P4W		
CT RATIO	Selectable through HMI up to 10000/5A		
CT LOCATION	Grid side / Load side		
CIRCUIT TOPOLOGY	3 level inverters (I type)		
RESPONSE TIME	50 μsec and full response less than 1 cycle		
TARGET POWER FACTOR	Adjustable from -1 to +1		
COOLING MODE	Forced air cooling		
NOISE LEVEL	< 65 dB		
NORMAL SPECTRUM OF COMPENSATION	Up to 15 <sup>th</sup> harmonics		
PROTECTION	Over current, Over voltage, Over temperature, IGBT saturation protection, Grid fault		
RELAY FOR CAPACITOR	8	0	
COMMUNICATION PORTS	MODBUS-RTU over RS485, Possible using LAN, WiFi (Paid basis)		
COMMUNICATION PROTOCOLS	MODBUS-RTU over RS485, Possible using LAN, WiFi (Paid basis)		
COMMUNICATION INTERFACE	Monochrome display	4.3" Touch screen HMI (7" available on request)	
SOFTWARE UPDATES	Possible through Wi-Fi or Laptop		
MOUNTING	Rack type, Wall Mount		
DIMENSIONS	485(H) x 280(W) x 228(D)mm	645(H) x 472(W) x 205(D)mm	795(H) x 472(W) x 204(D)mm
WEIGHT	25kg approx	45 kg approx	75 kg approx
COLOR	Black		
ALTITUDE	Less than 2000m (Higher altitudes on special request)		
OPERATING TEMPERATURE	-10°C ~ +40°C, 0...50°C maximum with current derating of 2 % per °C		
RELATIVE HUMIDITY	95%, no condensation		
IP PROTECTION CLASS	IP 2x		

*New*



- Hybrid Solution - Combination of Step based and stepless compensation
- Improved capacitor life due to minimum switching
- Instant response time of 50  $\mu$ sec & full response in less than 1 cycle for ASVG
- Capacitive (Leading) & Inductive (Lagging) reactive power mitigation
- Detuned reactor with every capacitor
- Advance feature- Harmonic correction up to 15<sup>th</sup> order
- Reputed make switchgear
- Easy to expand using common controller
- 18 step relay output

**ORDERING INFORMATION**

Eg : HYPNL-ASVG-100-50-R

Product Series	Product Type	Power (kVAr)	ASVG Rating	Output Type
HYPNL	ASVG	100 / 125 / 150 / 200 / 250 / 300 / 350 / 400 / 450 / 500	50 / 100	Relay / Transistor

**ACCESSORIES - COMMON CONTROLLER**

Eg : HYHMI-7-18-S

Product Name	Product Series	Display Screen	Relay Output	Communication
Common Controller	HYHMI	7"	18	S



- Mitigates voltage sags & swell
- Voltage spike & noise control
- Real-time voltage compensation
- Fault correction within 20msec

## FEATURES

<b>RATINGS</b>	Single Phase - 2.5kVA to 10kVA	Three Phase - 7.5kVA to 30kVA
<b>NOMINAL INPUT VOLTAGE</b>	230V AC	400V AC
<b>NORMAL OPERATING VOLTAGE</b> (Typical output regulation within 1% of nominal)	180 - 280V AC for full regulation	320 - 480V AC for full regulation
<b>OPERATING FREQUENCY</b>	47 - 65 Hz	
<b>MAXIMUM RATED INPUT CURRENT</b>	For 2.5kVA - 14A, For 5kVA - 27A For 7.5kVA - 42A, For 10kVA - 55A	For 7.5kVA - 14A per phase, For 15kVA - 27A per phase For 22.5kVA - 42A per phase, For 30kVA - 55A per phase
<b>INPUT MCB RATING</b>	For 2.5kVA - 20A, For 5kVA - 32A For 7.5kVA - 50A, For 10kVA - 63A	For 7.5kVA - 20A, For 15kVA - 32A For 22.5kVA - 50A, For 30kVA - 63A
<b>INPUT CONNECTION</b>	Terminal block (R, N and E)	Terminal block (R, Y, B, N and E)
<b>INPUT WIRE SIZE</b>	For 2.5kVA 4 sq.mm (AWG 12) ; For 5kVA - 6 sq.mm (AWG 10) For 7.5kVA - 6 sq.mm (AWG 10) ; For 10kVA - 10 sq.mm (AWG 8)	For 7.5kVA - 4 sq.mm (AWG 12) ; For 15kVA - 6 sq.mm (AWG 10) For 22.5kVA 6 sq.mm (AWG 10) ; For 30kVA - 10 sq.mm (AWG 8)
<b>ELIMINATES VOLTAGE SAGS</b>	Up to 50V (22 % considering 230V nominal)	
<b>SWELL COMPENSATION</b>	Up to 50V (20% considering 230V nominal)	
<b>COMPENSATION IRRESPECTIVE OF PHASE</b>	Yes	
<b>NOMINAL OUTPUT VOLTAGE</b>	230V AC	400V AC
<b>OUTPUT VOLTAGE RANGE</b>	220-230-240V AC (Selectable)	400VAC Ph - Ph ( 220-230-240V Ph- Neutral Selectable)
<b>POWER EFFICIENCY</b>	Typically over 97% (with 20-100 % load conditions)	
<b>CORRECTION</b>	Less than 20 msec	
<b>VOLTAGE COMPENSATION</b>	Up to 50V	
<b>MAXIMUM RATED OUTPUT CURRENT</b>	For 2.5kVA - 11A, For 5kVA - 22A For 7.5kVA - 33A, For 10kVA - 44A	For 7.5kVA - 11A/Ph, For 15kVA - 22A/Ph For 22.5kVA - 33A/Ph, For 30kVA - 44A/Ph
<b>VOLTAGE REGULATION</b>	±1%	
<b>RELAXED OPERATING VOLTAGE FOR ±10% COMPENSATION</b>	160 - 300V AC	277 - 520V AC
<b>OUTPUT CONNECTION</b>	Terminal block (L, N and E)	Terminal block (L1, L2, L3, N and E)
<b>LOAD BYPASS</b>	Auto (activated within 5 sec of fault detection) / Manual selectable	
<b>7 SEGMENT LED DISPLAY</b>	Regular input and output	
<b>BAR GRAPH LED</b>	Load indication with resolution of 10%	
<b>LED INDICATION</b>	Overload, Overvoltage, Undervoltage, Overcurrent	
<b>BUZZER INDICATION</b>	Power on, Overload, Overvoltage, Undervoltage, Overcurrent, Over temp	
<b>CAPACITY</b>	2.5kVA, 5kVA, 7.5kVA, 10kVA	7.5kVA, 15kVA, 22.5kVA, 30kVA
<b>POWER CONSUMPTION</b>	100VA	100VA per phase
<b>DIMENSIONS</b>	For 2.5kVA & 5kVA - 353(H) x 282(W) x 282(D) mm For 7.5kVA & 10kVA - 445(H) x 353(W) x 347(D) mm approx.	For 7.5kVA & 15kVA - 617.3(H) x 368(W) x 530(D)mm For 22.5kVA & 30kVA - 643 (H) x 470(W) x 780(D)mm approx.
<b>WEIGHT</b>	For 2.5kVA - 18 kg approx. , For 5kVA - 28 kg approx. For 7.5kVA - 35 kg approx. , For 10kVA - 50 kg approx.	For 7.5kVA - 60 kg approx. , For 15kVA - 85 kg approx. For 22.5kVA - 100 kg approx. , For 30kVA - 120 kg approx.
<b>MOUNTING</b>	4 High Quality Castor wheels	
<b>WARRANTY</b>	3 years	
<b>INPUT PROTECTION</b>	Line overcurrent, overvoltage, undervoltage	
<b>OUTPUT PROTECTION</b>	Overload, Over current trip	
<b>OVERLOAD &amp; SHORT-CIRCUIT</b>	Through suitable input circuit breaker	
<b>SURGE TEST CONDITIONS</b>	As per class 2 Surge (Combination wave)	
<b>SURGE LET-THROUGH VOLTAGES</b>	1.2 X 50µs, 6kV, 8 X 20µs, 3 kA waveform. L - N < 300V	
<b>AMBIENT TEMP.</b>	0 - 50°C, 10 to 90% RH non-condensing	
<b>IP PROTECTION CLASS</b>	IP 2x	

## Ordering information

### LED Power Factor Controllers

PRODUCT CODE	SUPPLY VOLTAGE	OUTPUT		CERTIFICATION
		STEPS	COMMN. (RS485)	
APFC147-108-90/550V	90 to 550V AC, 50 / 60Hz	8	---	---
APFC347-108-230V	85 to 270V AC, 50 / 60Hz	8	---	---
APFC147-108-90/550V-CE	90 to 550V AC, 50 / 60Hz	8	---	CE
APFC347-108-230V-CE	85 to 270V AC, 50 / 60Hz	8	---	CE

### LCD Power Factor Controllers

PRODUCT CODE	SUPPLY VOLTAGE	OUTPUT		CERTIFICATION
		STEPS	COMMN. (RS485)	
APFC148-312-90/550V	90 to 550V AC, 50 / 60Hz	12	YES	---
APFC148-312-90/550V-CE	90 to 550V AC, 50 / 60Hz	12	YES	CE
APFC146-112-90/550V-CE	90 to 550V AC, 50 / 60Hz	12	---	CE
APFC346-108-230V-CE	85 to 270V AC, 50 / 60Hz	8	---	CE

### Standard Duty Capacitor Banks

PRODUCT CODE	POWER	VOLTAGE	FREQUENCY	CURRENT	CAPACITANCE	DIMENSIONS
	kVAr	V	Hz	A	µF	mm
SDCAP01440	1	440	50	1.31	8.22	40 x 130
SDCAP02440	2	440	50	2.62	16.44	45 x 130
SDCAP03440	3	440	50	3.93	24.66	50 x 130
SDCAP04440	4	440	50	5.24	32.88	57 x 130
SDCAP05440	5	440	50	6.55	41.10	63 x 130
SDCAP07440	7.5	440	50	9.825	61.65	68 x 190
SDCAP10440	10	440	50	13.10	82.20	75 x 200
SDCAP12440	12	440	50	15.72	98.64	85 x 200
SDCAP15440	15	440	50	19.65	123.30	75 x 300
SDCAP20440	20	440	50	20.26	164.40	85 x 300
SDCAP25440	25	440	50	32.75	205.40	90 x 300

### Heavy Duty Capacitor Banks

PRODUCT CODE	POWER	VOLTAGE	FREQUENCY	CURRENT	CAPACITANCE	DIMENSIONS
	kVAr	V	Hz	A	µF	mm
<b>Heavy Duty - 440V</b>						
HDCAP01440	1	440	50	1.31	8.22	40 x 130
HDCAP02440	2	440	50	2.62	16.44	45 x 130
HDCAP03440	3	440	50	3.93	24.66	50 x 130
HDCAP04440	4	440	50	5.24	32.88	57 x 130
HDCAP05440	5	440	50	6.55	41.10	63 x 130
HDCAP07440	7.5	440	50	9.825	61.65	68 x 190
HDCAP10440	10	440	50	13.10	82.20	75 x 200
HDCAP12440	12 / 12.5	440	50	15.72	98.64	85 x 200
HDCAP15440	15	440	50	19.65	123.30	75 x 300
HDCAP20440	20	440	50	20.26	164.40	85 x 300
HDCAP25440	25	440	50	32.75	205.40	90 x 300

### Heavy Duty Capacitor Banks

PRODUCT CODE	POWER	VOLTAGE	FREQUENCY	CURRENT	CAPACITANCE	DIMENSIONS
	kVAr	V	Hz	A	µF	mm
<b>Heavy Duty - 480V</b>						
HDCAP05480	5	480	50	6.01	34.56	63 x 200
HDCAP10480	10	480	50	12.02	69.11	85 x 200
HDCAP15480	15	480	50	18.03	103.67	85 x 300
HDCAP20480	20	480	50	24.04	138.22	90 x 300
HDCAP25480	25	480	50	30.05	172.78	100 x 300
<b>Heavy Duty - 525V</b>						
HDCAP05525	5	525	50	5.49	28.85	63 x 200
HDCAP10525	10	525	50	10.99	57.7	85 x 200
HDCAP15525	15	525	50	16.48	86.55	85 x 300
HDCAP20525	20	525	50	21.98	115.4	90 x 300
HDCAP25525	25	525	50	27.47	144.25	100 x 300

### Advanced Static VAR Generators

PRODUCT CODE	DESCRIPTION
ASVG-050-WLL-4P-04	Advanced Static VAR Generator, 50 kVAR, Wall mounting, 3P-4W, with HMI Display 4.3 inch
ASVG-050-RCK-4P-04	Advanced Static VAR Generator, 50 kVAR, Rack mounting, 3P-4W, with HMI Display 4.3 inch
ASVG-050-WLL-4P-XX	Advanced Static VAR Generator, 50 kVAR, Wall mounting, 3P-4W, without display
ASVG-050-RCK-4P-XX	Advanced Static VAR Generator, 50 kVAR, Rack mounting, 3P-4W, without display
ASVG-050-WLL-3P-04	Advanced Static VAR Generator, 50 kVAR, Wall mounting, 3P-3W, with HMI Display 4.3 inch
ASVG-050-RCK-3P-04	Advanced Static VAR Generator, 50 kVAR, Rack mounting, 3P-3W, with HMI Display 4.3 inch
ASVG-050-WLL-3P-XX	Advanced Static VAR Generator, 50 kVAR, Wall mounting, 3P-3W, without display
ASVG-050-RCK-3P-XX	Advanced Static VAR Generator, 50 kVAR, Rack mounting, 3P-3W, without display
ASVG-100-WLL-4P-04	Advanced Static VAR Generator, 100 kVAR, Wall mounting, 3P-4W, with HMI Display 4.3 inch
ASVG-100-RCK-4P-04	Advanced Static VAR Generator, 100 kVAR, Rack mounting, 3P-4W, with HMI Display 4.3 inch
ASVG-100-WLL-4P-XX	Advanced Static VAR Generator, 100 kVAR, Wall mounting, 3P-4W, without display
ASVG-100-RCK-4P-XX	Advanced Static VAR Generator, 100 kVAR, Rack mounting, 3P-4W, without display
ASVG-100-WLL-3P-04	Advanced Static VAR Generator, 100 kVAR, Wall mounting, 3P-3W, with HMI Display 4.3 inch
ASVG-100-RCK-3P-04	Advanced Static VAR Generator, 100 kVAR, Rack mounting, 3P-3W, with HMI Display 4.3 inch
ASVG-100-WLL-3P-XX	Advanced Static VAR Generator, 100 kVAR, Wall mounting, 3P-3W, without display
ASVG-100-RCK-3P-XX	Advanced Static VAR Generator, 100 kVAR, Rack mounting, 3P-3W, without display

### Static Voltage Regulators

PRODUCT CODE	DESCRIPTION
SINE-1P-2.5-180/280V	Static Voltage Regulator, 1 phase 2.5kVA, 180 / 280V
SINE-1P-5-180/280V	Static Voltage Regulator, 1 phase 5kVA, 180 / 280V
SINE-1P-7.5-180/280V	Static Voltage Regulator, 1 phase 7.5kVA, 180 / 280V
SINE-1P-10-180/280V	Static Voltage Regulator, 1 phase 10kVA, 180/280V
SINE-3P-7.5-340/480V	Static Voltage Regulator, 3 phase 7.5kVA, 340 / 480V
SINE-3P-15-340/480V	Static Voltage Regulator, 3 phase 15kVA, 340 / 480V
SINE-3P-22.5-340/480V	Static Voltage Regulator, 3 phase 22.5kVA, 340 / 480V
SINE-3P-30-340/480V	Static Voltage Regulator, 3 phase 30kVA, 340 / 480V

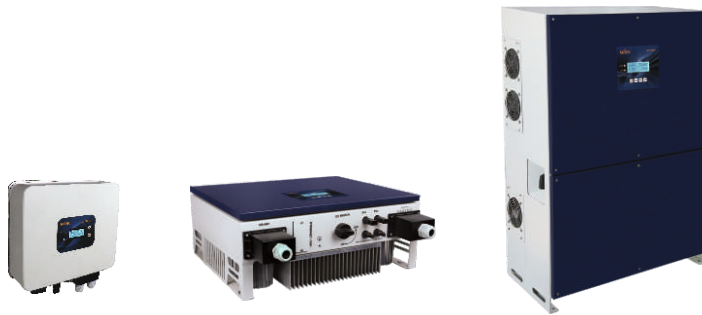

FEATURES	<ul style="list-style-type: none"> <li>• Anti-islanding protection</li> <li>• Wider MPPT range</li> <li>• Low start-up voltage</li> <li>• &gt;97% Efficiency</li> <li>• Ingress protection - IP65</li> <li>• Natural cooling convection</li> <li>• Remote monitoring</li> </ul>					
	MAX. DC INPUT POWER	3.3kW*	6kW	6kW*	10kW*	50kW*
MAX. ALLOWABLE PV POWER	4.2kW		7.5kW	12.5kW	75kW	150kW
NOMINAL PV VOLTAGE	360V		630V		600V	
MAX. DC INPUT VOLTAGE	550V	600	1000V		1000V	
START-UP VOLTAGE	80V		180V		200V	
OPERATING RANGE	65 - 550V	80-550	160 - 1000V		200 - 1000V	180 - 1000V
MPPT VOLTAGE RANGE	65 - 550V	80-550	160 - 1000V		200 - 1000V	180 - 1000V
MAX INPUT CURRENT / MPPT	13A	13.5A	11.6 / 11.6A		40A / 30A / 30A	26A
NUMBER OF MPPT	1	2	2		3	10
MAX INPUT STRINGS NUMBER	1		2		10	20
MAXIMUM PV SHORT CIRCUIT CURRENT PER MPPT (Isc)	16	16.9	16		55.5	40
RATED OUTPUT POWER	3.3kW	6	6kW	10kW	50kW	100kW
MAX. OUTPUT POWER	3.3kW	6	6.6kW	11kW	55kW	110kW
NOMINAL AC CURRENT, RMS	13.75A	25A	8.33A	13.9A	69.44	138.88A
MAX. OUTPUT CURRENT	16A	27.2A	10A	16A	84A	152.68A
GRID VOLTAGE RANGE	180 - 280V		320 - 480V		277 - 460V	
GRID FREQUENCY RANGE	50 / 60 Hz (45 - 55Hz / 55 - 65 Hz)					
POWER FACTOR (AT RATED OUTPUT POWER)	~ 1 (Adjustable from 0.8 leading to 0.8 lagging)					
TOTAL HARMONIC DISTORTION (THDi)	<3% at rated load					
FEED-IN PHASE/CONNECTION PHASE	Single Phase			Three Phase		
MAX. EFFICIENCY	97.40%	98.40	98.3%		98.9%	98.7%
MPPT EFFICIENCY	>99.5%	>99.9	>99.5%		>99.9%	
EURO EFFICIENCY	97.1%	97.5	97.7%	97.9%	98.4%	98.3%
PROTECTIONS	DC Reverse Polarity, Short Circuit, Over Current, Over / Under Voltage, Over / Under Frequency, Insulation resistance monitoring, Residual current detection, Surge Protection, Islanding Protection, Temperature Protection, Integrated DC Switch, [Integrated AFCI (DC arc-fault circuit protection) (Optional)]					
DC CONNECTION	MC4 Connectors					
DISPLAY	LCD with LED indications					
DATALOGGER & COMM.	RS485 / Wi-Fi / GSM* (Optional)					
TOPOLOGY	Transformerless					
CONSUMPTION @ NIGHT	< 0.5W	< 1W			< 1W	
OPERATING TEMP. RANGE	-25°C to 60°C					
COOLING METHOD	Natural convection					
RELATIVE HUMIDITY	0 to 100% non-condensing					
MAX. OPERATIONAL ALTITUDE	4000 m		3000 m		4000 m	
NOISE	<25 dBA		<30 dBA		<60 dBA	
DESIGNED LIFETIME	> 20 years					
WARRANTY	7 years					
IP PROTECTION CLASS	IP65					
DIMENSIONS (H x W x D)mm	313 x 275 x 131	375 x 310 x 157	500 x 500 x 200		580 x 830 x 295	680 x 1120 x 380
WEIGHT	5.2 kg approx.	10.8 kg approx.	26 kg approx.		86 kg approx.	100 kg approx.
MOUNTING	Wall mount					

NOTE : \* BIS Certified 

## Ordering information

\* Other ratings of 1.5kW, 2.5kW, 4.2kW, 5.2kW also available

\* Other ratings of 30kW,33kW also available

PRODUCT CODE	PHASE	DESCRIPTION
GTI003WLM1PW	SINGLE PHASE	Grid Tie Inverter - 1 Phase/ 3 kW, Wall mounted with Wifi Module
GTI006WLM1PW	SINGLE PHASE	Grid Tie Inverter - 1 Phase/ 6 kW, Wall mounted with Wifi Module

PRODUCT CODE	PHASE	DESCRIPTION
GTI006WLM3PW	THREE PHASE	Grid Tie Inverter - 3 Phase/ 06 kW, Wall mounted with Wifi Module
GTI010WLM3PW	THREE PHASE	Grid Tie Inverter - 3 Phase/ 10 kW, Wall mounted with Wifi Module
GTI050WLM3PW	THREE PHASE	Grid Tie Inverter - 3 Phase/ 50 kW, Wall mounted with Wifi Module
GTI100WLM3PW	THREE PHASE	Grid Tie Inverter - 3 Phase/ 100 kW, Wall mounted with Wifi Module



**640PSRV-CE**  
90(H) x 17.5(W) x 60(D)mm



**640PSR-CE**  
90(H) x 17.5(W) x 60(D)mm



**600PSR**  
90(H) x 17.5(W) x 60(D)mm



**800PSR**  
76.85(H) x 22.5(W) x 105.5(D)mm

<b>FEATURES</b>	<ul style="list-style-type: none"> <li>• LED Indication : Healthy and Trip conditions</li> <li>• Monitors Phase Failure, Sequence</li> <li>• Selectable Asymmetry</li> <li>• SPP / PSR selectable</li> <li>• Variable trip time delay : 2 to 10 sec</li> <li>• Under/ Over voltage - ON / OFF selectable</li> </ul>	<ul style="list-style-type: none"> <li>• LED Indication : Healthy and Trip conditions</li> <li>• Monitors Phase Failure, Sequence, Asymmetry</li> </ul>	<ul style="list-style-type: none"> <li>• Monitor Phase Failure, Sequence &amp; Asymmetry</li> <li>• LED indication : Relay ON</li> <li>• Slim space saving design</li> </ul>	<ul style="list-style-type: none"> <li>• Monitor Phase Failure, Sequence &amp; Asymmetry</li> <li>• LED indication : Relay ON</li> </ul>
<b>MODES</b>	Phase failure : Yes, Phase sequence : Yes, Phase asymmetry : 40V / 65V selectable, Reset : Auto reset on removal of fault condition, Under voltage : 310V fixed, Over voltage : 500V fixed	Phase failure : Yes, Phase sequence : Yes, Phase asymmetry : 40V fixed, Reset : Auto reset on removal of fault condition	Phase failure : Yes, Phase sequence : Yes, Phase asymmetry : 30V fixed, Reset : Auto reset on removal of fault condition	
<b>TIME RANGES</b>	Power ON delay : <400msec		Power ON delay : 200msec	
<b>ACCURACY</b>	±5% of F.S.		±3% of F.S.	
<b>OUTPUT CONTACT</b>	1 C/O (SPDT)			
<b>OUTPUT RATING</b>	NC : 3A@250V AC / 30V DC , NO : 5A@250V AC / 30V DC			
<b>ELECTRICAL CONNECTION</b>	3Ø - 3W			
<b>OPERATING VOLTAGE</b>	154 to 520V AC (L - L)		154 to 500V AC (L - L)	



**SPPA2M2**  
90(H) x 35(W) x 60(D)mm



**600SPP**  
90(H) x 17.5(W) x 60(D)mm

<b>FEATURES</b>	<ul style="list-style-type: none"> <li>• Monitor Phase Failure, Asymmetry, Over voltage &amp; Under voltage</li> <li>• LED indication : Power ON &amp; Trip</li> </ul>	<ul style="list-style-type: none"> <li>• Monitor Phase Failure &amp; Asymmetry</li> <li>• LED indication : Relay ON</li> <li>• Slim space saving design</li> </ul>
<b>MODES</b>	Phase failure : Yes, Phase sequence : Yes, Phase asymmetry : 30V fixed, Reset : Auto reset on removal of fault condition	Phase failure : Yes, Phase sequence : Yes, Phase asymmetry : 30V fixed, Reset : Auto reset on removal of fault condition
<b>TIME RANGES</b>	Power ON delay : 3sec	
<b>ACCURACY</b>	±1% of F.S.	
<b>OUTPUT CONTACT</b>	2 C/O (DPDT)	1 C/O (SPDT)
<b>OUTPUT RATING</b>	NC : 3A@250V AC / 30V DC , NO : 5A@250V AC / 30V DC	
<b>ELECTRICAL CONNECTION</b>	3Ø - 3W	
<b>OPERATING VOLTAGE</b>	280 to 520V AC (L - L)	154 to 500V AC (L - L)



**Auto switch-195/400V**  
76(H) x 20.5(W) x 85(D)mm



**Auto switch-313/457V**  
76(H) x 20.5(W) x 85(D)mm

<b>FEATURES</b>	<ul style="list-style-type: none"> <li>• Phase Failure, Sequence, Asymmetry ; Under Voltage, Over Voltage</li> <li>• Modes : Auto, Manual, Bypass</li> <li>• Pre-wired terminals</li> </ul>	
<b>MODES</b>	Phase failure : Yes, Phase sequence : Yes, Under voltage (UV) : Healthy to trip ≤195V, Trip to healthy ≥205V Over voltage (OV) : Healthy to trip ≥400V, Trip to healthy ≤390V	Phase failure : Yes, Phase sequence : Yes, Under voltage (UV) : Healthy to trip ≤313V, Trip to healthy ≥323V Over voltage (OV) : Healthy to trip ≥457V, Trip to healthy ≤447V
<b>MEASUREMENTS</b>	Phase Failure, Sequence, Asymmetry, Under voltage, Over voltage	
<b>OPERATING VOLTAGE RANGE</b>	195V AC - 400V AC (L - L) 50 - 60Hz	313V AC - 457V AC (L - L) 50 - 60Hz
<b>TIME SETTING</b>	Over voltage , Under voltage & Voltage unbalance : 3.5sec ±1.5sec Phase loss : Instantaneous (<400msec), Phase sequence Power ON delay (min) , Recovery time (min) : 0-10min Knob setting : (0, 0.5, 1, 3, 5 & 10)	
<b>OUTPUT RATING</b>	1 NO relay	
<b>RELAY RATING</b>	Contacts @ AC 15, 250V AC : 2A , Contacts @ AC 12, 250V AC : 5A	
<b>RELAY MODE</b>	Fail safe mode only	
<b>ACCURACY</b>	Timing accuracy ±5% of reading, Voltage accuracy ±1% of full scale (as per rated voltage)	

Voltage Monitoring Relays



**600DVR-CE**  
90(H) x 17.5(W) x 62(D)mm



**600VPR-310/520V**  
90(H) x 17.5(W) x 60(D)mm



**600VPR-170/290V**  
90(H) x 17.5(W) x 60(D)mm



**800VPR-3**  
76.85(H) x 22.5(W) x 105.5(D)mm

<b>FEATURES</b>	<ul style="list-style-type: none"> <li>• Monitor Under &amp; Over Voltage</li> <li>• Monitor Phase Failure, Sequence &amp; Asymmetry</li> <li>• Monitor Under, Over Frequency &amp; Neutral loss</li> </ul>	<ul style="list-style-type: none"> <li>• Monitors Under &amp; Over Voltage</li> <li>• Monitors Phase Failure &amp; Sequence</li> <li>• LED indication : Power ON, Fault condition</li> <li>• Space saving design</li> </ul>	<ul style="list-style-type: none"> <li>• Monitor Under &amp; Over Voltage</li> <li>• Monitor Phase Failure &amp; Sequence</li> <li>• LED indication : Power ON, Fault condition</li> </ul>	
<b>MODES</b>	Phase failure : Yes ; Phase sequence : Yes Phase asymmetry : 5-99% Over frequency : 45-65Hz Under Frequency : 45-65Hz Over Voltage : 280 to 600VAC (3Ø - 3W) (L-L) : 160 to 300VAC (3Ø - 4W) (L-N) Under Voltage : 280 to 600VAC (3Ø - 3W) (L-L) : 160 to 300VAC (3Ø - 4W) (L-N) Neutral Loss : Yes	Phase failure : Yes Phase sequence : Yes Under voltage : 310 to 405V AC Over voltage : 425 to 520V AC Reset : Auto reset on removal of fault condition	Phase failure : Yes Phase sequence : Yes Under voltage : 170 to 224V AC Over voltage : 236 to 290V AC Reset : Auto reset on removal of fault condition	Phase failure : Yes Phase sequence : Yes Under voltage : 310 to 405V AC Over voltage : 425 to 520V AC Reset : Auto reset on removal of fault condition
<b>TIME RANGES</b>	0-999 sec (For Power ON, Trip time, Recovery time) Response time < 120ms (For Under voltage, Over voltage, Phase asymmetry) Response time < 250ms (For Phase asymmetry, Phase failure, Phase sequence , Neutral loss)	Trip time delay : 0.2 to 10s, Power On delay : 400msec		
<b>ACCURACY</b>	Trip Voltage : +1% of Full Range Trip Time : +5% of setting + 250ms, Frequency : +0.3Hz	Trip Voltage : ±0.5% of F.S, Trip Time : ±5% of F.S		
<b>OUTPUT CONTACT</b>	1 C/O SPDT		1 C/O (SPDT)	
<b>OUTPUT RATING</b>	NO : 5A@250V AC / 30V DC, NC : 3A@250V AC / 30V DC		NC : 3A@250V AC / 30V DC, NO : 5A@250V AC / 30V DC	
<b>ELECTRICAL CONNECTION</b>	(3Ø - 3W), (3Ø - 4W)		3Ø - 3W	
<b>OPERATING VOLTAGE</b>	280 to 600VAC ( 3 Ø - 3W) (L-L) 160 to 300VAC ( 3 Ø - 4W) (L-N)	310 to 520V AC (L - L)	170 to 290V AC (L - L) 310 to 520V AC (L - L)	



**900VPR-2-280/600V-CE**  
90(H) x 35(W) x 70.5(D)mm



**900VPR-BL-U**  
90(H) x 35(W) x 70.5(D)mm

<b>FEATURES</b>	<ul style="list-style-type: none"> <li>Monitors Phase Failure, Sequence, Asymmetry, Under voltage, Over voltage, Under frequency and Over frequency</li> <li>Two separate alarm relays</li> <li>LED indication : Power ON, Fault condition</li> </ul>	<ul style="list-style-type: none"> <li>Monitors Phase Failure, Sequence, Asymmetry, Under voltage, Over voltage, Under frequency and Neutral loss</li> <li>Two alarm relays with NO or NC operation selectable</li> <li>LED indication : Fault condition</li> </ul>
<b>MEASUREMENTS</b>	Phase Failure, Sequence, Asymmetry, Under / Over voltage, Under / Over frequency, (Neutral Loss not applicable for 900VPR-2-280/520V)	
<b>DISPLAY</b>	3 digit LCD	3 digit LCD with backlight
<b>ALARM INDICATIONS</b>	Trip	
<b>ELECTRICAL CONNECTION</b>	1Ø - 2W (Only applicable for 900VPR-2-280/600V-CE), 3Ø - 3W, 3Ø - 4W	
<b>TRIP SETTING</b>	Under / Over voltage : 280 to 600V AC L-L (for 3Ø-3W), 160 to 300V AC L-N (for 3Ø-4W), Under / Over frequency : 45 / 65Hz, Voltage asymmetry : 5.0 to 99.9%	Under / Over voltage : 85 to 500V AC L - L (for 3Ø - 3W), 50 to 288V AC L - N (for 3Ø - 4W), Under / Over frequency : 45 / 65Hz, Phase asymmetry : 5.0 to 30.0%
<b>TRIP TIME SETTING</b>	Power ON delay : 0 to 999sec, Trip time delay : 0 to 999sec Recovery time delay : 0 to 999sec, Response time : <200ms	Power ON delay : 0.5 to 300sec, Trip time delay : 0 to 300sec Recovery time delay : 0 to 300sec (In Auto Reset Mode), Response time : <120ms
<b>HYSTERESIS</b>	Voltage : 1.0 to 99.9V, Frequency : 0.2 to 2Hz, Asymmetry: 2 to 20%	Voltage : 1.0 to 40V, Frequency : 0.2 to 2Hz, Asymmetry : 2 to 20%
<b>RESOLUTION</b>	Voltage : 1V, Frequency : 0.1Hz	
<b>ACCURACY</b>	Voltage : ±1% of set value, Frequency : ±0.3Hz, Time (Recovery time, Trip delay, Power on delay) : ±5% of setting ±200ms	Voltage : ±1% of set value ±2 digits, Frequency : ±0.5% ±1 digits, Time (Recovery Time, Trip delay, Power on delay) : ±5% of setting ±120ms
<b>OUTPUT CONTACT</b>	2 x 1 C/O (SPDT)	
<b>OUTPUT RATING</b>	NO : 5A@240V AC / 30V DC, NC : 3A@240V AC / 30V DC	NO : 5A@250V AC / 30V DC, NC : 3A@250V AC / 30V DC
<b>SUPPLY VOLTAGE</b> (AC : 50 / 60 Hz)	Self powered, Operating voltage : 280 to 600V AC (L-L), 160 to 300V AC (L-N)	85 to 270V AC / DC



**VPRA2M**  
90(H) x 35(W) x 70.5(D)mm



**VPRD2M**  
90(H) x 35(W) x 70.5(D)mm

<b>FEATURES</b>	<ul style="list-style-type: none"> <li>Monitors Under Voltage, Over Voltage</li> <li>Monitors Phase Failure, Sequence &amp; Asymmetry</li> <li>Adjustable over and under voltage trip level</li> <li>Adjustable trip time delay</li> </ul>	<ul style="list-style-type: none"> <li>Monitors Under Voltage, Over Voltage</li> <li>Monitors Phase Failure, Sequence &amp; Asymmetry</li> <li>Adjustable switching hysteresis</li> <li>One relay with two change over alarm relay operation</li> </ul>
<b>MEASUREMENT</b>	Phase Failure, Sequence, Asymmetry, Under voltage, Over voltage	
<b>DISPLAY</b>	Separate LED indications for Power ON, Phase failure, Phase sequence, Phase asymmetry, Under voltage, Over voltage,	3 digits LCD
<b>ELECTRICAL CONNECTION</b>	1Ø - 2W, 3Ø - 4W	
<b>TRIP SETTING</b>	Under voltage : 55 to 95% of Un [127 to 219V AC (L - N)] Over voltage : 105 to 125% of Un [242 to 288V AC (L - N)], Phase asymmetry : >10%	Under voltage : 127 to 219V AC (L - N) Over voltage : 242 to 288V AC (L - N), Phase asymmetry : 5 - 30 %
<b>TRIP TIME SETTING</b>	Power ON delay : 0 to 15sec, Trip time delay : 0 to 15sec Recovery time delay : 5sec ± 200ms, Phase sequence trip delay <250msec	Power ON delay : 0.5 to 300sec, Trip time delay : 0 to 300sec Recovery time delay : 0 to 300sec, Phase sequence trip delay <150msec
<b>HYSTERESIS</b>	Voltage : 7V (±2V) of trip voltage	Voltage : 1.0V - 99.9V, Asymmetry : 2 to 20%
<b>ACCURACY</b>	Trip setting : ±5% of F. S., Time setting : ±10% of F. S.	Voltage : ±1% ±2 digits, Time setting : ±5% of settings ± 150ms
<b>OUTPUT CONTACT</b>	2 C/O (DPDT)	
<b>OUTPUT RATING</b>	NC : 5A@250V AC / 30V DC, NO : 5A@250V AC / 30V DC	
<b>SUPPLY VOLTAGE</b> (AC : 50 / 60 Hz)	Self powered, Nominal input voltage (Un) : 230V AC (L - N), Operating voltage : 127 to 288V AC (L - N)	



## Current Monitoring Relays



**900CPR-1-BL-U**  
90(H) x 35(W) x 70.5(D)mm



**900CPR-3-1-BL**  
90(H) x 35(W) x 70.5(D)mm



**900CPR-1**  
90(H) x 35(W) x 70.5(D)mm



**900CPR-3**  
90(H) x 35(W) x 70.5(D)mm

<b>FEATURES</b>	<ul style="list-style-type: none"> <li>Monitors Under, Over Current protection for 1Ø system</li> <li>True RMS measurement</li> <li>Two alarm relay with NC or NO operation selectable</li> <li>LED indication : Fault condition</li> </ul>	<ul style="list-style-type: none"> <li>Monitors Under, Over Current &amp; Current Asymmetry protection for 1Ø &amp; 3Ø system</li> <li>True RMS measurement</li> <li>One alarm relay with NC or NO operation selectable</li> <li>LED indication : Fault condition</li> </ul>	<ul style="list-style-type: none"> <li>Monitors Under, Over Current protection for 1Ø system</li> <li>True RMS measurement</li> <li>One alarm relay with NC or NO operation</li> <li>LED indication : Fault condition</li> </ul>	<ul style="list-style-type: none"> <li>Monitors Under, Over Current &amp; Current Asymmetry protection for 1Ø &amp; 3Ø system</li> <li>True RMS measurement</li> <li>One alarm relay with NC or NO operation</li> <li>LED indication : Fault condition</li> </ul>
<b>MEASUREMENTS</b>	Under current, Over current (Current asymmetry applicable only for 900CPR-3, 900CPR-3-1-BL)			
<b>DISPLAY</b>	3 digit LCD with backlight		3 digits LCD	
<b>ELECTRICAL CONNECTION</b>	1Ø - 2W	1Ø - 2W, 3Ø - 3W, 3Ø - 4W	1Ø - 2W	1Ø - 2W, 3Ø - 3W, 3Ø - 4W
<b>CT SETTING</b>	CT Primary : 1A / 5A - 999A, CT Secondary : 1A / 5A (Selectable)			
<b>TRIP SETTING</b>	Under current : 0-999A, Over current : 0.5 - 1.19kA, (Current asymmetry : 5.0 – 99.9% applicable only for 900CPR-3, 900CPR-3-1-BL)			
<b>TRIP TIME SETTING</b>	Power ON delay : 0.5 – 99.9sec, Trip time delay : 0 - 99.9sec, Recovery time delay : 0 - 99.9sec, Response time : < 200ms			
<b>HYSTERESIS</b>	Current : 0.1 to 99.9A			
<b>ACCURACY</b>	Current : ±1% of setting ± 2 digits, Time (Recovery time, Trip delay, Power ON delay) : ±5% of setting ±200ms			
<b>OUTPUT CONTACT</b>	2 x 1 C/O (SPDT)	1C/O SPDT		
<b>OUTPUT RATING</b>	NO : 5A @ 250V AC / 30V DC; NC : 3A @ 250V AC / 30V DC			
<b>SUPPLY VOLTAGE</b> (AC : 50 / 60 Hz)	85 to 270V AC / DC	230V AC (±15%)		

## Earth Fault Relay



**900EFR-BL-U**  
90(H) x 35(W) x 70.5(D)mm



**EFR-341-2-CE**  
96(H) x 96(W) x 50(D)mm

<b>FEATURES</b>	<ul style="list-style-type: none"> <li>Earth fault current monitoring</li> <li>Two alarm relays with NO and NC operation selectable</li> <li>Test and reset via Front / Remote</li> </ul>	<ul style="list-style-type: none"> <li>Work with Normal CT and EFCT</li> <li>Earth fault current monitoring</li> <li>Two alarm relays with NO and NC operation selectable</li> <li>Test and reset via Front / Remote</li> </ul>
<b>MEASUREMENT</b>	Earth fault monitoring	Earth Fault Current monitoring
<b>DISPLAY</b>	3 digit liquid crystal display with backlight	3 digits, 7 Segments LED Display
<b>ELECTRICAL CONNECTION</b>	1Ø - 2W, 3Ø - 3W, 3Ø - 4W	(1Ø - 2W), (3Ø - 3W), (3Ø - 4W)
<b>FRAME RATING (CT PRIMARY)</b>	160A, 250A, 630A	---
<b>TRIP SETTING</b>	10% to 80% of selectable MCCB frame rating	Low set Value (10 to 1000 % of Primary Current) High set value 1A (10 to 1000% of primary current) High set value 5A (10 to 300% of primary current)
<b>TIME RANGES</b>	Response time : <100ms, Trip time delay : 0 to 99.9sec, Recovery time : 0 to 99.9sec, Power ON delay : 0.5 to 99.9sec	0.5-99.9 sec (For Power ON, Trip Time, Recovery Time)
<b>OUTPUT CONTACT &amp; RATING</b>	2 x 1 C/O (SPDT) NC : 3A@250V AC / 30V DC, NO : 5A@250V AC / 30V DC	2 x 2 C/O (SPDT) NO : 5A@250V AC / 30V DC, NC : 3A@250V AC / 30V DC

## Earth Fault Current Transformer



Description	Common Accessory for Earth Fault Relay
Current ratio	160/1A, 250/1A, 630/1A
Rated burden	1 VA
Sizes (mm)	100 x 25, 140 x 35, 180 x 35, 220 x 50

## Earth Leakage Relays



**600ELR**  
90(H) x 17.5(W) x 60(D)mm



**ELRA2M**  
90(H) x 35(W) x 60(D)mm



**900ELR-2**  
90(H) x 35(W) x 70.5(D)mm

<b>FEATURES</b>	<ul style="list-style-type: none"> <li>Monitors true RMS earth leakage current (Up to 500mA) in 1Ø &amp; 3Ø system</li> <li>Leakage current (In) &amp; Time delay (ΔT) adjustable</li> <li>LED indication for power ON and relay status</li> <li>Test and reset function via front key</li> </ul>	<ul style="list-style-type: none"> <li>Monitor true RMS earth leakage current up to 30A in 1Ø &amp; 3Ø system</li> <li>CBCT connection monitoring</li> <li>Test and reset via Front / Remote</li> <li>Sensitivity and time delay adjustable</li> </ul>	<ul style="list-style-type: none"> <li>Monitor true RMS earth leakage current up to 30A in 1Ø &amp; 3Ø system</li> <li>CBCT connection monitoring</li> <li>Test and reset via Front / Remote</li> <li>Two separate alarms relays with NO or NC operation selectable</li> </ul>
<b>MEASUREMENT</b>	Earth leakage current (Via external CBCT)		
<b>DISPLAY</b>	2 LED Indications (Power On and Relay Status)	5 LED indication	3 digit LCD with backlight, 2 LED for trip indication
<b>ELECTRICAL CONNECTION</b>	1Ø - 2W, 3Ø - 3W, 3Ø - 4W		
<b>TRIP SETTING</b>	30mA, 100mA, 300mA, 500mA	30mA to 30A	
<b>TIME RANGES</b>	Variable time settings (0, 2, 4, 6, 8, 10 sec) for 100mA, 300mA & 500mA current setting (For 1x1n) and <30ms for 5xIn.	Trip time delay : 0 to 9 sec (NA when In=0.03A)	Power ON delay : 0.5 to 99.9 sec, Trip time delay : 0 to 99.9 sec, Delay On release : 0 to 99.9 sec
<b>ACCURACY</b>	Current : 5% of In , Time : 5% of Set time	Current : ± 5% of Set Trip current Time : ± 5% of set Time + Response time	Current : ±5% of setting, Time (Recovery time, Trip delay, Power on delay) : ±5% of setting ±200ms
<b>OUTPUT CONTACT</b>	1 SPDT relay		2 x 1 C/O (SPDT)
<b>OUTPUT RATING</b>	NO : 5A @ 250VAC / 24V DC , NC: 3A @ 250VAC / 24V DC	NO : 10A@277V AC / 28V DC	NC : 3A@250V AC / 24V DC, NO : 5A@250V AC / 24V DC
<b>SUPPLY VOLTAGE</b> (AC : 50 / 60 Hz)	230V AC (± 15%)		



**ELR-341**  
96(H) x 96(W) x 50(D)mm



**ELCTR35**  
105(H) x 74(W) x 27(D)mm

<b>FEATURES</b>	<ul style="list-style-type: none"> <li>Monitor true RMS earth leakage current up to 30A in 1Ø &amp; 3Ø system</li> <li>CBCT connection monitoring</li> <li>Test and reset via Front / Remote</li> <li>Pre-alarm indication selectable</li> </ul>	<ul style="list-style-type: none"> <li>Monitors True RMS earth leakage current in 1Ø &amp; 3Ø system</li> <li>Inbuilt CBCT</li> <li>Test and reset function</li> </ul>
<b>MEASUREMENT</b>	Earth leakage current (Via external CBCT)	Earth leakage current (Internal CBCT)
<b>DISPLAY</b>	3 digits, 7 segments LED display	2 LED indication
<b>ELECTRICAL CONNECTION</b>	1Ø - 2W, 3Ø - 3W, 3Ø - 4W	
<b>TRIP SETTING</b>	30mA to 30A	75% of 30mA or 300mA
<b>TIME RANGES</b>	Power ON delay : 1 to 999 sec, Trip time delay : 0 to 9999 sec, Recovery time : 1 to 99 min	Reset time : Instantaneous
<b>ACCURACY</b>	Current : ± 5% of Set Trip current Time : ± 5% of set Time + Response time	Current : ± 5% of Input current Time : ± 5% of Response time
<b>OUTPUT CONTACT</b>	1 C/O SPDT	
<b>OUTPUT RATING</b>	NC : 3A@250V AC / 28V DC, NO : 5A@250V AC / 28V DC	
<b>SUPPLY VOLTAGE</b> (AC : 50 / 60 Hz)	90 to 270V AC / DC	230V AC (± 15%)



## Core Balance Current Transformers

<b>Description</b>	Common Accessory for ELR
<b>Operating current range</b>	30mA - 30A
<b>Sizes (inner diameter)</b>	35mm, 70mm, 120mm, 210mm, 310mm

## Motor Protection Relays



**MPR-3M**  
90(H) x 52.5(W) x 73(D)mm



**MPR-341-2**  
96(H) x 96(W) x 50(D)mm

<b>FEATURES</b>	<ul style="list-style-type: none"> <li>• Single phasing, Phase Sequence &amp; Asymmetry</li> <li>• Under Current, Overload trip Current</li> <li>• Test and reset function via Front / Remote</li> </ul>	<ul style="list-style-type: none"> <li>• Monitors Overload (As per NEMA class curve), Over, Under current, Current asymmetry, Lock current, Earth fault, Phase Failure, Sequence</li> <li>• LED indication : Power ON, Trip relay</li> <li>• Test &amp; reset function via Front / Remote</li> </ul>
<b>DISPLAY</b>	3 LED indication	7 segment, 4 digits LED
<b>AUXILLARY SUPPLY</b>	230 / 415V AC $\pm 15\%$	90V to 270V AC / DC
<b>ELECTRICAL CONNECTION</b>	3 $\emptyset$ - 3W	
<b>TRIP SETTING</b>	Phase asymmetry : 50% of motor current (Fixed) T(sec.) setting : To select 2, 4, 6, 8, 10 sec trip time curve in overload trip curve graph. Under current : 50% of Motor current, X Imax : To select motor current rating	Over load : Class 5,10,15,20,30, Over current : 4A to 480A, Under Current : 1A to 79A, Current asymmetry : 1A to 79A, Lock current : 4A to 480A, Earth fault : 1A to 160A
<b>TIME SETTINGS</b>	Single phase trip : 5 sec, Phase sequence : 5 sec, Phase asymmetry : 5 sec Over load trip : As per (IDMT Curve), Under current trip : 5 Sec	Power On delay : 1-999 sec, Trip time : 0-999 sec, Recovery time : 1-999 sec, Response time : <120ms, 3 Reset attempt time : 0-999 min
<b>MODE</b>	Auto / Manual / Remote	
<b>ACCURACY</b>	Time : $\pm 5\%$ of setting $\pm 100$ ms, Current : $\pm 5\%$ of set value	Current : $\pm 5\%$ of Ir $\pm 1$ digit, Timing : $\pm 5\%$ + 100msec
<b>OUTPUT CONTACT</b>	2 C/O (DPDT)	2 x1 C/O (SPDT)
<b>OUTPUT RATING</b>	NC : 5A@240V AC / 28V DC, NO : 5A@240V AC / 28V DC	

## 3 $\emptyset$ - Pump Protection Relays



**PPRD-4M-3-415V**  
90(H) x 70(W) x 60(D)mm



**PPRA-4M-3-415V**  
90(H) x 70(W) x 60(D)mm

<b>FEATURES</b>	<ul style="list-style-type: none"> <li>• Monitors Overload (As per NEMA class curve), Over, Under current, Current asymmetry, Lock current</li> <li>• Phase Failure, Sequence, Asymmetry, Over voltage and Under voltage</li> <li>• LED indication : Power ON, Trip relay</li> <li>• Test &amp; reset function via Front / Remote</li> </ul>	
<b>DISPLAY</b>	7 segment, 3 digits LED	4 LED & 4 knob for variable setting
<b>AUXILLARY SUPPLY</b>	280V-500V (L-L)	
<b>ELECTRICAL CONNECTION</b>	3 $\emptyset$ - 3W	
<b>CT SETTING</b>	10A, 40A, 80A	
<b>TRIP SETTING</b>	Over load : NEMA class curve 5,10,15,20,30, Over current : 4A to 480A, Under current : 1A to 79A, Current asymmetry : 1A to 79A, Lock current : 4A to 480A, Over voltage : 280V-500V, Under voltage : 280V-500V, Voltage asymmetry : 5V TO 50V	Over load : NEMA class curve 5,10,15,20,30, Over current : 10%-70% of Ir (Rated current) Under current : 20%-80% of Ir (Rated current), Current asymmetry : Fixed: 50% of Ir (Rated current) Lock current : Fixed 300% of Ir (Rated current), Over voltage : Fixed (480V), Under voltage : Fixed (350V), Voltage asymmetry : Fixed (30V)
<b>TIME SETTINGS</b>	Power On delay : 1 sec, Trip time : 0-999 sec, Recovery time : 1-999 sec , Response time : <120ms, 3 Reset attempt time : 0-999 min	Power ON delay : 1 sec (Fixed), Trip Time (sec) : 0,2,4,6,8 & 10, Recovery time : 15min, Response time : <240ms, 3 Reset attempt time : 60min (Fixed)
<b>HYSTERESIS</b>	Voltage : 0 to 10 V	Voltage : 6V (fixed)
<b>ACCURACY</b>	Current : $\pm 5\%$ of Ir $\pm 1$ digit, Timing : $\pm 5\%$ $\pm 100$ msec, Voltage : $\pm 1\%$ of 500V $\pm 1$ digit	
<b>OUTPUT CONTACT</b>	1 C/O (SPDT)	
<b>OUTPUT RATING</b>	5A@250V AC / 28V DC	

## Motor Protection Current Transformer



**MPCT**  
73(H) x 100(W) x 60(D)mm

<b>Description</b>	Common Accessory for MPR & PPR
<b>Current range</b>	10A, 40A, 80A

## 1Ø - Pump Protection Relays



**PPRD-4M-1-230V**  
90(H) x 70(W) x 60(D)mm



**PPRWD-4M-1-230V**  
90(H) x 70(W) x 60(D)mm



**PPRA-4M-1-230V**  
90(H) x 70(W) x 60(D)mm

<b>FEATURES</b>	<ul style="list-style-type: none"> <li>Monitors Over load (As per NEMA class curve), Over, Under current, Locked current</li> <li>Over voltage, Under voltage</li> <li>Direct current measuring up to 32A</li> <li>LED indication : Power ON, Trip relay</li> <li>Test &amp; Reset function via key &amp; terminal</li> </ul>	<ul style="list-style-type: none"> <li>Monitors Over load (As per NEMA class curve), Over, Under current, Locked current</li> <li>Over voltage, Under voltage</li> <li>Automatic pump on &amp; off as per water level detection</li> <li>Direct current measuring up to 32A</li> <li>Capacitor cut off features</li> </ul>	<ul style="list-style-type: none"> <li>Monitors Over load (As per NEMA class curve), Over, Under current, Locked current</li> <li>Over voltage, Under voltage,</li> <li>4 Knob for variable setting</li> <li>Direct current measuring up to 32A</li> <li>LED indication : Power ON, Trip relay</li> </ul>
<b>DISPLAY</b>	3 Digits, 7 Segment LED display	3 Digits, 7 Segment LED display	3 LED & 4 Knob for variable Setting
<b>ELECTRICAL CONNECTION</b>	1Ø - 2W		
<b>MEASURING RANGE</b>	A) Motor rated current Measuring : 1A to 30 A B) Voltage measuring range : 180 to 300VAC (L - N)		
<b>TRIP SETTING</b>	Over load : NEMA class curve 5, 10, 15, 20, 30 , Over current : 2A to 32A, Under current : 0.2 to 29A, Locked current : 2A to 32A Over voltage : 180V - 300V (L - N), Under voltage : 180V - 300V (L - N)		Over load : NEMA class curve 5, 10, 15, 20, 30 , Over current : 10% to 70%, Under current : 20% to 80% Locked current : 300% of Ir, Over voltage : 280V (fixed) Under voltage : 180V (fixed)
<b>TIME SETTINGS</b>	Power ON delay : 1 sec (Fixed), Trip time delay : 0 - 999 sec Recovery time : 1 - 999 sec, Reset attempts 3 (fixed) : 1 - 999 min		Power ON delay : 1 sec (fixed), Trip time delay : 0 - 10 sec Auto Reset Time : 15 min, Reset attempts 3 (fixed) : 60 min
<b>ACCURACY</b>	Current accuracy : ±5% of rated current ±1 digit, Voltage accuracy : ±1% of 300V ±1 digit, Time accuracy : ±5% ±100msec		
<b>OUTPUT CONTACT</b>	1 NO relay	2 NO relay	1 NO relay
<b>OUTPUT RATING</b>	30A@277V AC		
<b>SUPPLY VOLTAGE (AC : 50 / 60 Hz)</b>	180 to 300V AC (L - N)		

## Liquid Level Controllers



**WLCA2M1**  
90(H) x 35(W) x 60(D)mm



**LLCA-2M-U-CE**  
90(H) x 35(W) x 60(D)mm

<b>FEATURES</b>	<ul style="list-style-type: none"> <li>Used for drain &amp; fill control</li> <li>3 No's stainless steel prods</li> <li>10A SPDT output (Resistive)</li> </ul>	<ul style="list-style-type: none"> <li>Selectable suction and delivery mode in single tank operation</li> <li>Used for single and two tank liquid level monitoring</li> <li>Pump protection from dry run and overflow</li> <li>Adjustable trip &amp; recovery time delay</li> <li>Manual start facility</li> </ul>
<b>DISPLAY</b>	2 LED indication	4 LED indication
<b>AUXILLARY SUPPLY</b>	85 to 270V AC / DC	
<b>TRIP SETTING</b>	According to the levels of sensor placed in the water tank	
<b>SENSITIVITY</b>	1 ohms to 200Kohms	0 ohms to 500Kohms
<b>TRIP TIME</b>	0.5s	0.5s to 10s
<b>MODE</b>	Auto	Auto / Manual
<b>ACCURACY</b>	±5% + 100msec	
<b>OUTPUT CONTACT</b>	1 C/O (SPDT)	1 N/O & 1 N/C
<b>OUTPUT RATING</b>	10A@250V AC / 28V DC	6A@ 277 V AC / 28V DC

## Liquid Level Sensor



- Stainless steel
- Suitable for conductive liquids

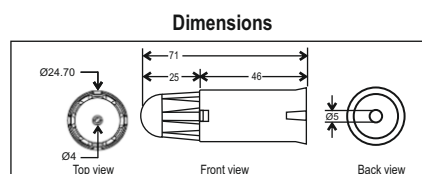

## Thermistor Protection Relay



**TPRA2M1-1-U-CE**  
90(H) x 35(W) x 60(D)mm

## Annunciator



**AN-8-0-0-230V**  
147(H) x 76(W) x 63(D)mm

FEATURES	<ul style="list-style-type: none"> <li>• PTC input</li> <li>• LED indication : Power ON, Trip, Open, Short</li> <li>• DPDT relay output</li> </ul>	FEATURES	<ul style="list-style-type: none"> <li>• 8 Programmable windows</li> <li>• 6 Colour selection</li> <li>• RS485 MODBUS RTU protocol</li> </ul>
LED INDICATION	Green : Power ON indication, Yellow : Sensor Indication, Red : Relay status	DISPLAY	Multicolour LED's - Fault annunciation
INPUT TYPE	PTC sensor	NO. OF KEYS	4
SENSOR	Sensor short : <40 ( $\pm 1\Omega$ ), Sensor healthy : 44 $\Omega$ ( $\pm 3\Omega$ ) to <3.8K $\Omega$ ( $\pm 150\Omega$ ) Sensor trip : $\geq 3.8K\Omega$ ( $\pm 150\Omega$ ) to <5.5K $\Omega$ ( $\pm 150\Omega$ ) Sensor open : $\geq 5.5K\Omega$ ( $\pm 150\Omega$ ) & above Sensor cut-in : $\leq 1.5K\Omega$ ( $\pm 60\Omega$ )	DIGITAL INPUTS	13
		OPERATING RANGE	5 - 30V DC
FUNCTIONAL	Relay operating mode : Fail-safe & Shunt-trip mode, Reset : Auto / Manual	INPUT CURRENT	3mA @ 12V
OUTPUT CONTACT	2 C/O (DPDT)	DIGITAL OUTPUTS	2
OUTPUT RATING	8A@250V AC	OUTPUTS TYPE	NO contact type - Relay
		OUTPUT CURRENT	7A @ 30VDC (Resistive), 7A @ 250VAC (Resistive)
		COMMUNICATION PROTOCOL	RS485 MODBUS RTU protocol
		MOUNTING	Panel mount
		SUPPLY VOLTAGE	90 - 270V AC
		SENSOR SUPPLY	12V, 50mA (for looping)

## Ordering information

### Line Monitoring Relay

PRODUCT CODE	SUPPLY VOLTAGE	CERTIFICATION
640PSR-CE	154 to 520V AC	CE
640PSR-V-CE	154 to 520V AC	CE
600PSR-CE	154 to 500V AC	CE
800PSR	154 to 500V AC	---
642PSR	280 to 520V AC	---
600SPP	154 to 500V AC	---
SPPA2M2	280 to 520V AC	---

### Auto Switch

PRODUCT CODE	SUPPLY VOLTAGE	CERTIFICATION
Auto switch-195/400V	195 to 400V AC	---
Auto switch-313/457V	313 to 457V AC	---

### Earth Fault Relay

PRODUCT CODE	SUPPLY VOLTAGE	CERTIFICATION
900EFR-BL-U-CE	85 to 270V AC / DC	CE
EFR-341-2-CE	85 to 270V AC / DC	CE

### Earth Leakage Relay

PRODUCT CODE	SUPPLY VOLTAGE	CERTIFICATION
600ELR-1-30/500mA-230V	230V AC ( $\pm 15\%$ )	---
900ELR-2-230V-CE	230V AC ( $\pm 15\%$ )	CE
ELRA2M2-1-230V-CE	230V AC ( $\pm 15\%$ )	CE
ELR-341-1	90 to 270V AC / DC	---
ELCTR35-1-30mA-230V-CE	230V AC ( $\pm 15\%$ )	CE
ELCTR35-1A-30mA-230V	230V AC ( $\pm 15\%$ )	---
ELCTR35-1-300mA-230V-CE	230V AC ( $\pm 15\%$ )	CE
ELCTR35-1A-300mA-230V	230V AC ( $\pm 15\%$ )	---

### Core Balance Current Transformer



PRODUCT CODE	INNER DIAMETER (IN MM)	CERTIFICATION
CBCT-35-1-CE	35	CE
CBCT-70-1-CE	70	CE
CBCT-120-1-CE	120	CE
CBCT-210-1-CE	210	CE
CBCT-310-1-CE	310	CE

## Ordering information

### Earth Fault Current Transformer

PRODUCT CODE	DIMENSION IN MM	CURRENT TRANSFORMER RATIO
EFCT 100/25 160/1A VA CL1	100x25	160/1A
EFCT 140/35 160/1A VA CL1	140x35	160/1A
EFCT 140/35 250/1A VA CL1	140x35	250/1A
EFCT 180/35 250/1A VA CL1	180x35	250/1A
EFCT 180/35 630/1A VA CL1	180x35	630/1A
EFCT 220/50 630/1A VA CL1	220x50	630/1A

### Voltage Monitoring Relay

PRODUCT CODE	SUPPLY VOLTAGE	CERTIFICATION
600DVR-CE	280 to 600V AC	CE
600VPR-170/290-CU	170 to 290V AC	CE 
600VPR-310/520-CE	310 to 520V AC	CE
800VPR-3	310 to 520V AC	---
900VPR-2-280/520V	280 to 520V AC	---
900VPR-2-280/520V-CU-RoHS	280 to 520V AC	CE 
900VPR-2-280/600V-CU-RoHS	280 to 600V AC	CE 
900VPR-BL-U-CE	85 to 270V AC / DC	CE
VPRA2M-CE	127 to 288V AC	CE
VPRD2M	127 to 288V AC	---
VPRD2M-BL-CE	127 to 288V AC	CE

### Current Monitoring Relay

PRODUCT CODE	SUPPLY VOLTAGE	CERTIFICATION
900CPR-1-BL-U-CE	85 to 270V AC / DC	CE
900CPR-3-1-BL-230V-CE	230V AC (±15%)	CE
900CPR-1-230V	230V AC (±15%)	---
900CPR-3-230V	230V AC (±15%)	---

### Motor / Pump Protection Relay

PRODUCT CODE	SUPPLY VOLTAGE	CERTIFICATION
MPR-3M-2-230V	230V AC (± 15%)	---
MPR-3M-2-415V	415V AC (± 15%)	---
MPR-341-2	90 to 270V AC / DC	---
PPRD-4M-3-415V	415V AC (± 15%)	---
PPRA-4M-3-415V	415V AC (± 15%)	---
PPRD-4M-1-230V	180 to 300V AC	---
PPRWD-4M-1	180 to 300V AC	---
PPRA-4M-1-230V	180 to 300V AC	---

### Motor Protection Current Transformer

PRODUCT CODE	INPUT CURRENT	CERTIFICATION
MPCT D15 10 A	10 A	---
MPCT D15 40 A	40 A	---
MPCT D15 80 A	80 A	---

### Liquid Level Controller & Accessories

PRODUCT CODE	SUPPLY VOLTAGE	CERTIFICATION
WLCA2M1-CE-RoHS	85 to 270V AC / DC	CE
WLCA-2M-U-CE	85 to 270V AC / DC	CE
LLCA-2M-1-U-CE-RoHS	85 to 270V AC / DC	CE
PRODUCT CODE	DESCRIPTION	
WLC SENSOR	Set of 3 Numbers	

### Thermistor Protection Relay

PRODUCT CODE	OUTPUT	SUPPLY VOLTAGE	CERTIFICATION
TPRA2M1-1-U-CE	RELAY	90 to 270V AC / DC	CE

### Annunciator

PRODUCT CODE	CERTIFICATION
AN-8-0-0-230V	---

## Astronomical Time Switch

## Daily / Weekly Time Switches



**ATS2M1-1-16A**  
90(H) x 35(W) x 60(D)mm



**TS2M1-2-16A**  
90(H) x 35(W) x 60(D)mm



**TS2M1-1-16A**  
90(H) x 35(W) x 60(D)mm



**TS1W1-1-20A**  
60(H) x 60(W) x 47.65(D)mm

<b>FEATURES</b>	<ul style="list-style-type: none"> <li>Latitude / Longitude precise to the minute with time zone</li> <li>Automatic calculation of sunrise &amp; sunset times</li> <li>DST offset / power saving mode</li> <li>1 channel</li> <li>10 years power reserve (replaceable battery)</li> </ul>	<ul style="list-style-type: none"> <li>1 sec least count</li> <li>30 ON - 30 OFF steps per day</li> <li>2 channel</li> <li>Auto / Permanent override ON / Permanent Override OFF</li> <li>10 years power reserve (replaceable battery)</li> </ul>	<ul style="list-style-type: none"> <li>1 sec least count</li> <li>50 ON - 50 OFF steps per day</li> <li>1 channel</li> <li>Auto / Permanent override ON / Permanent Override OFF</li> <li>10 years power reserve (replaceable battery)</li> </ul>
<b>DISPLAY</b>	Text LCD (Without backlight)		
<b>RTC SHIFT</b>	6 minutes a year @ 25°C		
<b>OUTPUT CONTACT</b>	1 C/O SPDT	2 x 1 C/O SPDT	1 C/O SPDT
<b>CONTACT RATING</b>	16A @ 250V AC	16A @ 250V AC	20A @ 250V AC
<b>WEEKLY PROGRAM</b>	---	For Relay 1 - Total 30 ON steps and 30 OFF steps 1 program 30 steps, 2 programs 15 steps, 3 programs 10 steps, 4 programs 07 steps, 5 programs 06 steps. ( Same for Relay 2)	Total 50 ON steps and 50 OFF steps - 2 program 25 steps, 3 programs 16 steps, 4 programs 12 steps, 5 programs 10 steps, 6 programs 08 steps, 7 programs 07 steps, 8 programs 06 steps
<b>MINIMUM SETTING UNIT</b>	---		1 second
<b>HOLIDAY SETTINGS</b>	---		16 dates
<b>CLOCK</b>	12hr (AM / PM) and 24hr selection		
<b>RELAY OPERATING MODE</b>	Auto / Permanent override ON / Permanent override OFF		
<b>SUPPLY VOLTAGE (AC : 50 / 60 Hz)</b>	230V AC ±10%		

## Analog Timers



**600ST**  
90(H) x 17.5(W) x 60(D)mm



**600XU**  
90(H) x 17.5(W) x 60(D)mm



**600SD**  
90(H) x 17.5(W) x 60(D)mm



**642SQ-A**  
90(H) x 17.5(W) x 63.5(D)mm



**642XA**  
90(H) x 17.5(W) x 63.5(D)mm

<b>FEATURES</b>	<ul style="list-style-type: none"> <li>Single function - ON delay</li> <li>10 Time ranges</li> </ul>	<ul style="list-style-type: none"> <li>Multi function (13 Functions)</li> <li>Precise analog time setting</li> <li>Universal supply voltage</li> </ul>	<ul style="list-style-type: none"> <li>Star Delta</li> <li>1 C/O Relay each for Star &amp; Delta</li> </ul>	<ul style="list-style-type: none"> <li>2 Functions</li> <li>8 Time ranges</li> </ul>		
<b>MODES</b>	ON delay	A, B, C, Ci, D, E, F, H, I, J, K, Ai, Bi	Star - Delta	ON delay / Interval		
<b>TIME RANGES</b>	0.1 - 1sec, 0.3 - 3sec, 1 - 10sec, 3 - 30sec, 0.1 - 1min, 0.3 - 3min, 1 - 10min, 3 - 30min, 0.1 - 1hr, 0.3 - 3hr		Run up time : 3 - 30sec, 6 - 60sec Change over : 50/100ms	0 - 3sec / min, 0 - 10sec / min, 0 - 30sec / min, 0 - 60sec / min		
<b>RESOLUTION</b>	0.1sec	0.1sec	---	0.3sec		
<b>ACCURACY</b>	Setting : ±5% of F.S Repeat : ±0.5% F.S. Pause time accuracy : ±5% ±5ms					
<b>OUTPUT CONTACT</b>	1 C/O SPDT	1 C/O SPDT	1 C/O Relay each for Star & Delta	1 C/O SPDT		
<b>CONTACT RATING</b>	5A @ 250V AC / 24V DC					
<b>SUPPLY VOLTAGE (AC : 50 / 60 Hz)</b>	240V AC	20 to 240V AC, 12 to 240V DC	230V AC	230V AC, 24V AC / DC		
<b>Modes</b>	<table border="1"> <tr> <td>600XU</td> <td>A - ON delay, B - Interval, C - Repeat cycle equal OFF first, Ci - Repeat cycle equal ON first, D - Pulse output 500ms fixed, E - Delay on break, F - Delay on make / Delay on break, H - Interval after break, I - Single shot, J - Retriggerable single shot, K - Latching relay, Ai - Delay on break with Totalise, Bi - Interval with Totalise</td> </tr> </table>				600XU	A - ON delay, B - Interval, C - Repeat cycle equal OFF first, Ci - Repeat cycle equal ON first, D - Pulse output 500ms fixed, E - Delay on break, F - Delay on make / Delay on break, H - Interval after break, I - Single shot, J - Retriggerable single shot, K - Latching relay, Ai - Delay on break with Totalise, Bi - Interval with Totalise
600XU	A - ON delay, B - Interval, C - Repeat cycle equal OFF first, Ci - Repeat cycle equal ON first, D - Pulse output 500ms fixed, E - Delay on break, F - Delay on make / Delay on break, H - Interval after break, I - Single shot, J - Retriggerable single shot, K - Latching relay, Ai - Delay on break with Totalise, Bi - Interval with Totalise					



**800XU**  
75(H) x 22.5(W) x 105.5(D)mm



**800XA**  
75(H) x 22.5(W) x 105.5(D)mm



**800SQ-A**  
75(H) x 22.5(W) x 105.5(D)mm



**800S**  
75(H) x 22.5(W) x 105.5(D)mm

<b>FEATURES</b>	<ul style="list-style-type: none"> <li>• 2 Functions</li> <li>• 12 Time ranges</li> <li>• Universal supply voltage</li> </ul>	<ul style="list-style-type: none"> <li>• 2 Functions</li> <li>• 8 Time ranges</li> <li>• Universal supply voltage</li> </ul>	<ul style="list-style-type: none"> <li>• 2 Functions</li> <li>• 8 Time ranges</li> </ul>	<ul style="list-style-type: none"> <li>• Single function</li> <li>• Fixed time range (60sec)</li> </ul>
<b>MODES</b>	ON delay / Interval			ON delay
<b>TIME RANGES</b>	1 / 3 / 10 / 30sec / min / hr	3 / 10 / 30 / 60sec / min	3 / 10 / 30 / 60sec / min	60sec
<b>RESOLUTION</b>	0.1sec	0.3sec	0.3sec	6sec
<b>ACCURACY</b>	Setting : ±5% of F.S. Repeat : ±0.5% or 50ms (Whichever is greater)			
<b>OUTPUT CONTACT</b>	2 C/O SPDT	2 C/O SPDT	1 C/O SPDT	1 C/O SPDT
<b>CONTACT RATING</b>	5A @ 250V AC / 24V DC			
<b>SUPPLY VOLTAGE (AC : 50 / 60 Hz)</b>	20 to 240V AC, 12 to 240V DC		230V AC & 24V AC / DC	230V AC, 415V AC



**800SD-2**  
75(H) x 22.5(W) x 105.5(D)mm



**800XC**  
75(H) x 22.5(W) x 105.5(D)mm



**800XMR**  
75(H) x 22.5(W) x 105.5(D)mm



**800POD**  
75(H) x 22.5(W) x 105.5(D)mm

<b>FEATURES</b>	<ul style="list-style-type: none"> <li>• Star delta</li> <li>• 1 C/O Relay each for Star &amp; Delta</li> </ul>	<ul style="list-style-type: none"> <li>• Asymmetrical cyclic</li> <li>• 6 Time ranges</li> </ul>	<ul style="list-style-type: none"> <li>• Forward pause reverse</li> <li>• 1 C/O Relay each for Forward &amp; Reverse</li> </ul>	<ul style="list-style-type: none"> <li>• True power OFF delay</li> <li>• Fixed time range (180sec)</li> </ul>
<b>MODES</b>	Star - Delta	Asymmetrical Cyclic ON first or OFF first	Forward - Pause - Reverse	True Power OFF Delay
<b>TIME RANGES</b>	Run up time : 30 / 60sec Change over : 50 / 100msec	1 / 10sec / min / hr for both ON & OFF time	ON time : 1 / 2 / 4 / 8min Pause time : 10 / 20 / 40 / 80s	180sec
<b>RESOLUTION</b>	---	0.1sec	ON time : 6s Pause time : 0.1s	7.5sec
<b>ACCURACY</b>	Setting : ±5%, Repeat : ±0.5% of F.S or 50ms			Setting : ±10% of F.S. Repeat : ±2% or 100ms
<b>OUTPUT CONTACT</b>	1 C/O Relay each for Star & Delta	2 C/O SPDT	1 C/O Relay each for Forward & Reverse	2 C/O SPDT
<b>CONTACT RATING</b>	5A @ 250V AC / 24V DC			
<b>SUPPLY VOLTAGE (AC : 50 / 60 Hz)</b>	110V AC, 230V AC 230 to 415V AC	20 to 240V AC, 12 to 240V DC		110 to 240V AC / DC



**55XU**  
48(H) x 48(W) x 70.5(D)mm



**55XC**  
48(H) x 48(W) x 70.5(D)mm



**55ES**  
48(H) x 48(W) x 70.5(D)mm

<b>FEATURES</b>	<ul style="list-style-type: none"> <li>• Plug / Panel mount</li> <li>• ON delay / Interval</li> <li>• 12 Time ranges</li> </ul>	<ul style="list-style-type: none"> <li>• Plug / Panel mount</li> <li>• Asymmetrical Cyclic ON - OFF</li> <li>• 6 Time ranges</li> </ul>	<ul style="list-style-type: none"> <li>• Plug / Panel mount</li> <li>• ON delay / Interval</li> <li>• 8 Time ranges</li> </ul>
<b>BASE TYPE</b>	P8 - 8 Pin plug, T8 - Screw terminal		
<b>MODES</b>	ON delay / Interval	Asymmetrical Cyclic ON first or OFF first	ON delay / Interval
<b>TIME RANGE</b>	1 / 3 / 10 / 30sec / min / hr	1 / 10sec / min / hr for both ON & OFF time	3 / 10 / 30 / 60sec / min
<b>RESOLUTION</b>	0.1sec		0.3sec
<b>ACCURACY</b>	Setting : ± 5% of F.S., Repeat : ± 0.5% or 50 ms		
<b>OUTPUT CONTACT</b>	2 C/O SPDT		1 C/O SPDT
<b>CONTACT RATING</b>	5A @ 250V AC / 24V DC		
<b>SUPPLY VOLTAGE (AC : 50 / 60 Hz)</b>	20 to 240V AC, 12 to 240V DC		230V AC, 24V AC / DC



## Analog Timers

## Digital Timers



**55MF**  
48(H) x 48(W) x 70.5(D)mm



**600DT**  
90(H) x 17.5(W) x 62(D)mm

FEATURES	<ul style="list-style-type: none"> <li>Multi function (10 Functions)</li> <li>Wide time range (0.05sec to 300hr)</li> <li>Universal supply voltage</li> </ul>	<ul style="list-style-type: none"> <li>Multi function (15 Functions)</li> <li>Wide time range (0.1sec to 999hr)</li> <li>Universal supply voltage</li> </ul>
DISPLAY	---	3 + 3 digits
SET POINT	---	Single set point
MODES	A, B, C, D, E, F, G, H, I, J	A, B, C, D, E, F, H, J, K, L, P, Q, R, T, U
TIME RANGES	0.05sec to 300hr	9.99 / 99.9 / 999sec, 9 : 59min : sec, 99.9 / 999min, 9 : 59hr : min, 99.9 / 999hr
RESOLUTION	0.05sec	0.01sec
TIME SETTING	Front knobs	Front keypad
RESET / START INPUT	Start : Gate/Pulse start (Depending on modes) Reset : Terminal / Remote	Start : Gate/Pulse start (Depending on modes) Reset : Front panel, On power interruption
ACCURACY	Setting : ± 5% of F.S., Repeat : ± 0.5% or 50 ms	Setting : ± 0.1% of F.S. or ±50ms, For Y contact operation : +100ms, Repeat : ± 0.1%
OUTPUT CONTACT	2 x 1 C/O SPDT	1 C/O SPDT
CONTACT RATING	6A @ 250V AC / 24V DC, resistive	8A @ 250V AC
SUPPLY VOLTAGE (AC : 50 / 60 Hz)	20 to 240V AC / DC	20 to 240V AC / DC

Modes	600DT	55MF-P11	55MF-P8
	A - ON delay, B - Interval, C - Asymmetrical cyclic OFF first, D - Asymmetrical cyclic ON first, E - Repeat cycle equal OFF first, F - Repeat cycle equal ON first, H - Pulse output, J - Delay on break, K - Delay on make/Delay on break, L - Interval after break, P - Single shot, Q - Retriggerable single shot, R - Latching relay, T - Delay on break with totalise, U - Interval with totalise	A - Signal ON delay, B - Interval, C - Cyclic Equal OFF first, D - Cyclic Equal ON first, E - Signal OFF delay, F - Signal ON / OFF delay, G - Interval after break H - Single shot, I - Retriggerable single shot, J - Delay on make/Delay on break	A - ON delay, B - Pulse output with instantaneous limit, C - ON delay instantaneous limit, D - Interval with instantaneous limit, E - Cyclic equal OFF first, F - Cyclic equal OFF first with instantaneous limit, G - Cyclic equal ON first, H - Cyclic equal ON first with instantaneous limit, I - Star delta with 50ms pause time, J - Star delta with 100ms pause time

## Ordering information

### Digital Time Switches

PRODUCT CODE	SUPPLY VOLTAGE	CERTIFICATION
ATS2M1-1-16A-230V-CE	230V AC	CE
TS2M1-2-16A-230V-CE	230V AC	CE
TS2M1-1-16A-230V V2	230V AC	---
TS2M1-1-16A-230V-CE	230V AC	CE
TS1W1-1-20A-230V	230V AC	---
TS1W1-1-20A-230V-CE	230V AC	CE

### Analog Timers

PRODUCT CODE	SUPPLY VOLTAGE	CERTIFICATION
800XU-CU	20 to 240V AC, 12 to 240V DC	CE, UL
800XA	20 to 240V AC, 12 to 240V DC	---
800XA-CE	20 to 240V AC, 12 to 240V DC	CE
800SQ-A	230V AC, 24V AC/DC	---
800S-1-ON-60S-230	230V AC	---
800S-1-ON-60S-415	415V AC	---
800SD-2-230	230V AC	---
800SD-2-230-CE	230V AC	CE
800SD-2-110	110V AC	---
800SD-2-415	230 to 415V AC	---
800XC	20 to 240V AC, 12 to 240V DC	---
800XC-CE	20 to 240V AC, 12 to 240V DC	CE
800XMR	20 to 240V AC, 12 to 240V DC	---
800POD-180S	110 to 240V AC / DC	---

### Analog Timers

PRODUCT CODE	SUPPLY VOLTAGE	CERTIFICATION
600XU-A-1-CU	20 to 240V AC, 12 to 240V DC	CE, UL
600SD-2-230	230V AC	CE
600ST	240V AC	CE
600ST-CU	240V AC	CE, UL
642SQ-A	230VAC, 24V AC / DC	---
642XA	20 to 240V AC, 12 to 240V DC	---
55XU-P8-230V-G	20 to 240V AC, 12 to 240V DC	CE, UL
55XU-T-230V-G	20 to 240V AC, 12 to 240V DC	CE, UL
55XC-P8-230V-G	20 to 240V AC, 12 to 240V DC	CE, UL
55XC-T-230V-G	20 to 240V AC, 12 to 240V DC	CE, UL
55ES-P8-230V-G	230V AC, 24V AC / DC	CE, UL
55ES-T-230V-G	230V AC, 24V AC / DC	CE, UL
55MF-P11	20 to 240V AC / DC	CE
55MF-P8	20 to 240V AC / DC	CE

### Digital Timers

PRODUCT CODE	SUPPLY VOLTAGE	CERTIFICATION
600DT	20 to 240V AC / DC	CE
600DT-CU	20 to 240V AC / DC	CE, UL

## Programmable Timer

## Thumbwheel Timers



**XT543N**  
48(H) x 48(W) x 100(D)mm



**XT56-N**  
48(H) x 48(W) x 60(D)mm



**XT264-3**  
72(H) x 72(W) x 115(D)mm



**XT364-3**  
96(H) x 96(W) x 90(D)mm

<b>FEATURES</b>	<ul style="list-style-type: none"> <li>Multi function (4 Functions)</li> <li>9 Time ranges</li> <li>Single set point</li> </ul>	<ul style="list-style-type: none"> <li>Thumbwheel setting</li> <li>6 Time ranges</li> <li>Single set point</li> </ul>
<b>DISPLAY</b>	3 digits	
<b>SET POINT</b>	Single set point	
<b>MODES</b>	ON delay / Interval / Cyclic ON first / Cyclic OFF first	ON delay / Interval
<b>TIME RANGES</b>	9.99 / 99.9 / 999sec, 9 : 59min : sec, 99.9 / 999min, 9 : 59hr : min, 99.9 / 999hr	9.99 / 99.9 / 999sec, 99.9 / 999min, 99.9hr
<b>RESOLUTION</b>	0.01sec	
<b>TIME SETTING</b>	Front keypad	Thumbwheel
<b>RESET / START INPUT</b>	Start : Gate / Pulse start (Programmable)	Start : Pulse start
	Reset : Front panel, Remote reset, On power interruption	
<b>ACCURACY</b>	±0.5% of F.S. or 50ms	
<b>OUTPUT CONTACT</b>	2 C/O SPDT	
<b>CONTACT RATING</b>	5A @ 250V AC or 24V AC / DC	
<b>SUPPLY VOLTAGE (AC : 50 / 60 Hz)</b>	90 to 270V AC / DC [24V DC (Optional) - For XT56-N]	

## Programmable Timer

## Multifunction

## Sequential Timer



**XT546BX**  
48(H) x 48(W) x 76(D)mm



**XT546** 48(H) x 48(W) x 94(D)mm  
**XT246** 72(H) x 72(W) x 83.7(D)mm  
**XT346** 96(H) x 96(W) x 73(D)mm



**XT5042**  
48(H) x 48(W) x 100(D)mm



**PT380**  
96(H) x 96(W) x 100(D)mm

<b>FEATURES</b>	<ul style="list-style-type: none"> <li>Short depth</li> <li>Multi function (4 Functions)</li> <li>9 Time ranges</li> <li>Single set point</li> </ul>	<ul style="list-style-type: none"> <li>Multi function (4 Functions)</li> <li>9 Time ranges</li> <li>Single set point</li> </ul>	<ul style="list-style-type: none"> <li>Multi function (7 Functions)</li> <li>Pulse start (Input through PNP / NPN sensor)</li> <li>Dual set point</li> <li>Individual time setting for relays</li> </ul>	<ul style="list-style-type: none"> <li>8 Channels</li> <li>4 Functions</li> <li>Parallel / Sequential operation</li> <li>Cascade output for channel expansion</li> </ul>
<b>DISPLAY</b>	3 + 3 digits		4 + 4 digits	2 + 4 digits
<b>SET POINT</b>	Single set point		Dual set point	Single set point
<b>MODES</b>	ON delay / Interval / Cyclic ON first / Cyclic OFF first		ON delay / Interval / Cyclic ON first / Cyclic OFF first / Forward-Pause-Reverse / Instantaneous + Delayed / Timer / Batch	ON delay / Interval / Cyclic ON first / Cyclic OFF first (Start up delay & no. of cycles programmable for cyclic mode)
<b>TIME RANGES</b>	9.99 / 99.9 / 999sec, 9.59min : sec, 99.9 / 999min, 9.59hr : min, 99.9 / 999hr		99.99 / 999.9 / 9999sec, 99.59min : sec, 999.9 / 9999min, 99.59hr : min, 999.9 / 9999hr	99.99sec, 999.9sec, 99.59min : sec, 99.59hr : min, 999.9hr
<b>RESOLUTION</b>	0.01sec			
<b>DIRECTION</b>	Up / Down	Down	Up / Down	Up
<b>TIME SETTING</b>	Front keypad			
<b>NO. OF CHANNELS</b>	—			8 Channels
<b>RESET/START INPUT</b>	Start : Gate / Pulse start (Programmable) Reset : Front panel, Remote reset, On power interruption			
<b>ACCURACY</b>	±0.05% of F.S. or 50ms			±0.5% of F.S. or 50ms
<b>OUTPUT CONTACT</b>	2 C/O SPDT		2 C/O SPST	8 NOs with 1 Com
<b>CONTACT RATING</b>	5A @ 250V AC or 24V DC			
<b>MEMORY RETENTION</b>	10 years (User selectable)			
<b>SUPPLY VOLTAGE (AC : 50 / 60 Hz)</b>	85 to 270V AC / DC [24V DC (Optional) - For XT546 & XT246]		90 to 270V AC / DC or 24V DC	85 to 270V AC / DC

## Time Interval Meter / Hours Meters



**T1103C**  
48(H) x 96(W) x 88(D)mm



**TT412B**  
36(H) x 72(W) x 74.5(D)mm



**LT945A**  
24(H) x 48(W) x 48(D)mm  
**With Clamp**  
48(H) x 48(W) x 48(D)mm

<b>FEATURES</b>	<ul style="list-style-type: none"> <li>• Time Interval Meter</li> <li>• Range : Auto ranging, Fixed ranges</li> </ul>	<ul style="list-style-type: none"> <li>• Time totaliser</li> <li>• Selectable least count</li> <li>• Inbuilt sensor supply</li> <li>• Universal power supply</li> </ul>	<ul style="list-style-type: none"> <li>• LCD Hour Meter</li> <li>• Battery powered</li> <li>• Contact / Voltage input</li> </ul>
<b>DISPLAY</b>	4 digits	6 digit 7 segment LED Display	7½ digits
<b>TIME RANGES</b>	a) Auto ranging : .0001 to 9999sec b) Fixed ranges : .9999, 9.999, 99.99, 999.9, 9999sec	a) 99999.9 sec, b) 999999 sec c) 99999.9 min, d) 999999 min e) 99999.9 hrs, f) 999999 hrs	a) 1999.59.59hr:min:sec b) 199999.99hr
<b>ACCURACY</b>	±0.05% +1 count	±0.05%	
<b>INPUT</b>	Potential free contact & 3 to 30V DC from solid state devices	Potential free contact, PNP Sensor	a) 24 to 260V AC / DC b) Contact input
<b>RESET</b>	Front, Remote (Reset time : 20ms), Auto	Terminal	Remote
<b>MEMORY</b>	---	10 years	5 years
<b>SUPPLY VOLTAGE (AC : 50 / 60 Hz)</b>	90 to 270V AC / DC		Battery powered

## Digital Counters



**XC22B V2**  
72(H) x 72(W) x 115(D)mm



**XC1200**  
48(H) x 96(W) x 88(D)mm



**XC2200**  
72(H) x 72(W) x 78(D)mm

<b>FEATURES</b>	<ul style="list-style-type: none"> <li>• Thumbwheel setting</li> <li>• Auto reset</li> <li>• Battery backup</li> <li>• Memory retention</li> </ul>	<ul style="list-style-type: none"> <li>• Counter with rate indicators</li> <li>• Programmable input scaling</li> <li>• Up, Down, Quadrature &amp; Bi-directional modes</li> <li>• Dual set point</li> </ul>	<ul style="list-style-type: none"> <li>• Counter with rate indicator</li> <li>• Programmable input scaling</li> <li>• Unidirectional, Bi-directional &amp; Quadrature modes</li> <li>• Batch counter</li> </ul>
<b>DISPLAY</b>	4 digits	6 digits	6 + 4 digits
<b>MODES</b>	ON delay / Interval / Auto reset	ON delay / Interval / Auto reset / Time pulse repeat	
<b>RANGES</b>	9999 counts	Selectable least count : 0.0001, 0.001, 0.01, 0.1 & 1 Rate : 4.00 to 99999 RPM / RPH	-999 to 999999 counts
<b>RESET</b>	Front, Remote, Auto (Optional)	Front (user selectable), Remote	Front, Remote, Power interruption
<b>MEMORY</b>	Yes (Optional)	Yes	
<b>DIRECTION</b>	Up	Up, Down, Bi-directional, Quadrature	
<b>SET POINT</b>	Single set point	Dual set point	
<b>INPUT SPEED</b>	30Hz, 5kHz (Selectable via dip switch)	30Hz, 2.5kHz, 5kHz (Programmable)	30Hz, 5kHz (Programmable)
<b>SCALE FACTOR</b>	---	0.00001 to 9.99999 x 10 <sup>n</sup> , n= -5, -4, -3, -2, -1, 0, 1, 2	
<b>SENSOR SUPPLY</b>	Inbuilt, 12V DC @30mA		
<b>OUTPUT CONTACT</b>	2 C/O SPDT	2 C/O SPDT	
<b>CONTACT RATING</b>	5A @ 250V AC or 24V DC	5A @ 250V AC or 24V DC	
<b>INPUT</b>	NPN, PNP sensor, Potential free contact	NPN / PNP sensor, Potential free contact, Encoder	
<b>SUPPLY VOLTAGE (AC : 50 / 60 Hz)</b>	90 to 270V AC / DC		

## Speed Monitoring Relay

## Counters



**SMRD4M1**  
90(H) x 70(W) x 62(D)mm



**XC410B**  
36(H) x 72(W) x 74.5(D)mm



**XC10D**  
48(H) x 96(W) x 88(D)mm

<b>FEATURES</b>	<ul style="list-style-type: none"> <li>• Under, Over, Dual speed modes</li> <li>• Dual set point</li> <li>• RPH, RPM, RPS ranges</li> <li>• Scalable input, Auto ranging</li> </ul>	<ul style="list-style-type: none"> <li>• Count Totaliser</li> <li>• Compact size</li> <li>• Inbuilt sensor supply</li> <li>• Universal power supply</li> </ul>	<ul style="list-style-type: none"> <li>• LED Counter</li> <li>• Inbuilt sensor supply</li> <li>• Compact size</li> </ul>
<b>DISPLAY</b>	4 digits	6 digit 7 segment LED Display	6 digits
<b>MODES</b>	---		
<b>RANGES</b>	Auto ranging, RPH, RPM or RPS	999999 counts	
<b>RESET</b>	---	Front, Terminal	Front, Remote
<b>MEMORY</b>	---	Yes, 10 Years	Yes
<b>DIRECTION</b>	Up		
<b>SET POINT</b>	---		
<b>INPUT SPEED</b>	4 to 9999 pulses per minute	20Hz, 5kHz	3Hz, 30Hz, 1kHz (Selectable via jumper)
<b>SENSOR SUPPLY</b>	Inbuilt, 12V DC, ±10%, 30mA	12VDC@30mA	
<b>INPUT</b>	NPN, PNP sensor, Potential free contacts		
<b>SUPPLY VOLTAGE (AC : 50 / 60 Hz)</b>	90 to 270V AC / DC		

## Digital Timer - Counter

## Time / Count Totaliser



**XTC5400**  
48(H) x 48(W) x 100(D)mm



**XTC4102**  
36(H) x 72(W) x 74.5(D)mm



**LTC9A**  
24(H) x 48(W) x 48(D)mm

<b>FEATURES</b>	<ul style="list-style-type: none"> <li>• Multi function - Timer / Counter (programmable)</li> <li>• Batch counter</li> <li>• Up / Down counting for counter</li> <li>• Dual set point</li> </ul>	<ul style="list-style-type: none"> <li>• LED count/ time totalizer</li> <li>• Compact size</li> <li>• Inbuilt sensor supply</li> </ul>	<ul style="list-style-type: none"> <li>• Time / Count totaliser</li> <li>• Battery powered</li> <li>• Contact / Voltage input selectable</li> </ul>
<b>DISPLAY</b>	4 + 4 digits	6 digits White LED display	7 <sup>1/2</sup> digits
<b>MODES</b>	Timer : ON delay / Interval / Cyclic ON first / Cyclic OFF first / Batch. Counter : ON delay / Interval / Auto reset / Time pulse repeat / Batch	---	Timer / Counter
<b>RANGES</b>	Timer : 99.99/999.9/9999sec, 99:59min:sec, 999.9/9999min, 99:59hr:min, 999.9/9999hr, Counter : -999 to 9999 counts	Counter : 999999 counts Timer : 99999.9 sec, 999999 sec, 99999.9 min, 999999 min, 99999.9 hrs, 999999 hrs	Hour meter : a) 1999.59.99 hr:min:sec ; b) 199999.99hr Counter : 19999999 counts
<b>RESET</b>	Front, Remote, Power interruption	Counter - Front key, Timer - Terminal	Front, Remote
<b>MEMORY</b>	Yes	10 years retention	5 years
<b>DIRECTION</b>	Timer : Down, Counter : Up / Down	Up	
<b>SET POINT</b>	Dual set point	---	
<b>INPUT SPEED</b>	3Hz, 30Hz, 5kHz (Programmable)	20Hz, 5kHz	14Hz, 100Hz (Selectable via jumper)
<b>SENSOR SUPPLY</b>	Inbuilt, 12V DC @30mA		
<b>SCALE FACTOR</b>	0.001 to 9.999 x 10 <sup>n</sup> n = -3, -2, -1, 0, 1, 2	---	
<b>OUTPUT CONTACT</b>	2 C/O SPST	---	
<b>CONTACT RATING</b>	5A @ 250V AC or 24V DC	---	
<b>INPUT</b>	NPN, PNP sensor, Potential free contacts	Counter : 5 to 30V DC from Proximity switches, Encoders, Potential free contacts, Limit switches etc. Timer : Potential free contact	a) 24 to 260V AC / DC b) Contact input
<b>SUPPLY VOLTAGE (AC : 50 / 60 Hz)</b>	90 to 270V AC / DC	90 to 270V AC/DC or 12 to 24V DC (Non isolated)	Battery powered

## Ordering information

### Digital Timers

PRODUCT CODE	SUPPLY VOLTAGE	CERTIFICATION
XT543-N	90 to 270V AC / DC	---
XT56-N	90 to 270V AC / DC	---
XT56-N-24	24V DC	---
XT56-N-CE	90 to 270V AC / DC	CE
XT264-3	90 to 270V AC / DC	---
XT364-3	90 to 270V AC / DC	---
XT546BX	85 to 270V AC	---
XT546	85 to 270V AC	---
XT546-24V	24V DC	---
XT546-CE	85 to 270V AC	CE
XT246	85 to 270V AC	---
XT246-24V	24V DC	---
XT346	85 to 270V AC	---
XT5042	90 to 270V AC / DC	---
XT5042-24	24V DC	---
XT5042-CU	90 to 270V AC / DC	CE & 
PT380	85 to 270V AC / DC	---

### Time Interval Meter / Hour Meters

PRODUCT CODE	SUPPLY VOLTAGE	CERTIFICATION	
TI103C	90 to 270V AC / DC	---	
TT412B	90 to 270V AC / DC	---	
PRODUCT CODE	INPUT TYPE		CERTIFICATION
	CONTACT	VOLTAGE	
LT945A-C	YES	---	---
LT945A-V	---	YES	---
LT945A-C-CE	YES	---	CE
LT945A-V-CE	---	YES	CE

### Digital Counters

PRODUCT CODE	SUPPLY VOLTAGE	CERTIFICATION
XC22B V2	90 to 270V AC / DC	---
XC1200	90 to 270V AC / DC	CE
XC2200	90 to 270V AC / DC	---
XC2200-CE	90 to 270V AC / DC	CE

### Digital Timer-Counter

PRODUCT CODE	SUPPLY VOLTAGE	CERTIFICATION
XTC5400	90 to 270V AC / DC	CE
XTC5400-CU	90 to 270V AC / DC	CE & 
XTC4102-CE	90 to 270V AC / DC	CE

### LCD / LED Counters

PRODUCT CODE	INPUT TYPE		CERTIFICATION
	CONTACT	VOLTAGE	
LTC9A	YES	YES	CE
PRODUCT CODE	SUPPLY VOLTAGE		CERTIFICATION
XC410B	90 to 270V AC / DC		---
XC10D	90 to 270V AC / DC		---

### Speed Monitoring Relay

PRODUCT CODE	SUPPLY VOLTAGE	CERTIFICATION
SMRD4M1-2-U-CE	90 to 270V AC / DC	CE

## Temperature Controllers (CX Series)



<b>FEATURES</b>	<ul style="list-style-type: none"> <li>• Dual bright display, Dual set point</li> <li>• TC / RTD input</li> <li>• Control output : Relay or SSR</li> <li>• Auxiliary output : Relay</li> <li>• Dwell timer, Heat cool PID</li> <li>• IDM applicable</li> </ul>	<ul style="list-style-type: none"> <li>• Single White display, Single set point</li> <li>• Control output : Relay or SSR</li> <li>• High power Relay</li> <li>• TC / RTD input</li> <li>• IDM applicable</li> </ul>
<b>DISPLAY</b>	4 + 4 digits, 7 segment LED dual (White+Green) display	
<b>INPUT TYPE</b>	Thermocouple (J, K, T, R, S) / RTD (PT100)	
<b>RESOLUTION</b>	0.1/ 1° for TC / RTD (fixed 1° for R & S TC)	Fixed 1° resolution
<b>ACCURACY</b>	For TC inputs : 0.25% of F.S. ±1° ; For R & S inputs : 0.5% of F.S. ±1° (20 min of warm up time); For RTD input : 0.1% of F.S. ±1°	
<b>SETPOINT</b>	Dual set point	Single Set point
<b>CONTROL MODE</b>	Auto/Self tune PID or ON - OFF	
<b>CONTROL OUTPUT</b>	Relay : SPDT 5A (SPST for TC544C) resistive @ 250V AC / 30V DC or SSR (Field Selectable) : 12V DC, 50mA	Relay : SPDT 10A resistive @ 250V AC / 30V DC or SSR : 12V DC, 50mA
<b>AUXILIARY OUTPUT</b>	Relay : SPDT 5A (SPST for TC544C) resistive @ 250V AC / 30V DC	---
<b>SPECIAL FUNCTIONS</b>	Heat cool PID, Dwell timer, IDM applicable	IDM applicable
<b>SUPPLY VOLTAGE</b> (AC : 50 / 60 Hz)	90 to 270V AC / DC	

## Temperature Controllers (BX Series)

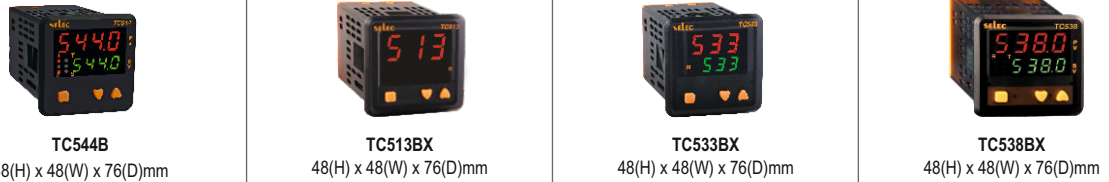

<b>FEATURES</b>	<ul style="list-style-type: none"> <li>• TC / RTD input</li> <li>• ON-OFF / PID control (Auto tune / self tune)</li> <li>• Dual set point</li> <li>• Selectable control output : Relay / SSR</li> <li>• Auxiliary output : Relay</li> </ul>	<ul style="list-style-type: none"> <li>• Single display, Single set point</li> <li>• Short depth TC</li> <li>• TC / RTD input</li> <li>• Control output : Relay or SSR</li> </ul>	<ul style="list-style-type: none"> <li>• Dual display, Single set point</li> <li>• Short depth TC</li> <li>• TC / RTD input</li> <li>• Control output : Relay or SSR</li> </ul>	<ul style="list-style-type: none"> <li>• Dual display, Single set point</li> <li>• Short depth TC</li> <li>• TC / RTD input</li> <li>• Control output : Relay or SSR</li> </ul>
<b>DISPLAY</b>	4 + 4 digits, 7 segment LED dual display	3 digits, 7 segment LED single display	3 + 3 digits, 7 segment LED dual display	4 + 4 digits, 7 segment LED dual display
<b>INPUT TYPE</b>	Thermocouple (J, K, T, R, S) / RTD (PT100)			
<b>RESOLUTION</b>	0.1/ 1° for TC/ RTD inputs (fixed 1° for R & S type TC input)	Fixed 1° resolution		
<b>ACCURACY</b>	For TC input : 0.25% of F.S. ±1° ; For R & S inputs : 0.5% of F.S. ±2° (20 min of warm up time for TC inputs); For RTD input : 0.1% of F.S. ±1°			
<b>SETPOINT</b>	Dual set point	Single set point		
<b>CONTROL MODE</b>	Auto tune / Self tune PID or ON-OFF			
<b>CONTROL OUTPUT</b>	Relay : SPST : 5A resistive @ 250V AC / 30V DC or SSR : 12V DC, 30mA	Relay : SPDT : 10A resistive @ 250V AC / 30V DC or SSR : 12V DC, 50mA		
<b>AUXILIARY OUTPUT</b>	Relay : 5A resistive @ 230V AC / 30V DC	---		
<b>SPECIAL FUNCTIONS</b>	Heat cool PID, Dwell timer	---		
<b>SUPPLY VOLTAGE</b> (AC : 50 / 60 Hz)	90 to 270V AC / DC			

## Temperature Controllers (AX Series)



**TC544A**  
48(H) x 48(W)  
x 94(D)mm

**TC244AX**  
72(H) x 72(W)  
x 83.7(D)mm

**TC344AX**  
96(H) x 96(W)  
x 73(D)mm



**TC513AX**  
48(H) x 48(W)  
x 94(D)mm

**TC203AX**  
72(H) x 72(W)  
x 83.7(D)mm

**TC303AX**  
96(H) x 96(W)  
x 73(D)mm



**TC533AX**  
48(H) x 48(W)  
x 94(D)mm

<b>FEATURES</b>	<ul style="list-style-type: none"> <li>Dual display, Dual set point</li> <li>TC / RTD input</li> <li>Control output : Relay or SSR</li> <li>Auxiliary output : Relay</li> <li>Dwell timer, Heat cool PID</li> </ul>	<ul style="list-style-type: none"> <li>Single display, Single set point</li> <li>TC / RTD input</li> <li>Control output : Relay or SSR</li> </ul>	<ul style="list-style-type: none"> <li>Dual display, Single set point</li> <li>TC / RTD input</li> <li>Control output : Relay or SSR</li> </ul>
<b>DISPLAY</b>	4 + 4 digits, 7 segment LED dual display	3 digits, 7 segment LED single display	3 + 3 digits, 7 segment LED dual display
<b>INPUT TYPE</b>	Thermocouple (J, K, T, R, S) / RTD (PT100)		
<b>RESOLUTION</b>	0.1 / 1° for TC / RTD (fixed 1° for R & S TC)	Fixed 1° resolution	
<b>ACCURACY</b>	For TC inputs : 0.25% of F.S. ±1° ; For R & S inputs : 0.5% of F.S. ±2° (20 min of warm up time); For RTD input : 0.1% of F.S. ±1°		
<b>SETPOINT</b>	Dual set point	Single set point	
<b>CONTROL MODE</b>	Autotune PID or ON - OFF		
<b>CONTROL OUTPUT</b>	Relay : SPDT (SPST for TC544A) : 5A resistive @ 250V AC / 30V DC or SSR (Field Selectable) : 12V DC, 50mA	Relay : SPDT (SPST for TC303A) : 10A resistive @ 250V AC / 30V DC or SSR : 12V DC, 50mA (except TC303A)	
<b>AUXILIARY OUTPUT</b>	Relay : SPDT (SPST for TC544A) : 5A resistive @ 250V AC / 30V DC	---	
<b>SPECIAL FUNCTIONS</b>	Heat cool PID, Dwell timer	---	
<b>SUPPLY VOLTAGE (AC : 50 / 60 Hz)</b>	90 to 270V AC / DC, 24V DC (Optional for TC544 Only)	90 to 270V AC / DC & 24V DC (Optional for TC513AX only)	



**DTC503**  
48(H) x 48(W) x 76(D)mm



**DTC231**  
72(H) x 72(W) x 83.7(D)mm



**DTC331**  
96(H) x 96(W) x 38.8(D)mm



**DTC204A-2**  
72(H) x 72(W) x 83.7(D)mm



**DTC324A-2**  
96(H) x 96(W) x 73(D)mm

<b>FEATURES</b>	<ul style="list-style-type: none"> <li>3 Digit single display</li> <li>J, K TC input</li> <li>ON-OFF / PID control</li> </ul>	<ul style="list-style-type: none"> <li>3 Digit single display</li> <li>J, K TC input</li> <li>ON-OFF mode</li> </ul>	<ul style="list-style-type: none"> <li>Single display, Dual set point</li> <li>TC / RTD input</li> <li>Control output : Relay or SSR</li> <li>Auxiliary output : Relay</li> </ul>
<b>DISPLAY</b>	3 digits, 7 segment LED single display		4 digits, 7 segment LED single display
<b>INPUT TYPE</b>	Thermocouple (J, K)		Thermocouple (J, K, T, R, S) / RTD (PT100)
<b>RESOLUTION</b>	Fixed 1° resolution		0.1 / 1° for TC / RTD inputs (Fixed 1° for R & S type TC input)
<b>ACCURACY</b>	For J, K inputs : 0.25% of F.S. ±1°C	0.25% of F.S. ±1° (20 min warm up time)	For TC Inputs : 0.25% of F.S. ±1°; For R & S Inputs : 0.5% of F.S. ±2° (20 min of warm up time); For RTD Input : 0.1% of F.S. ±1°
<b>SETPOINT</b>	Single set point		Dual set point
<b>CONTROL MODE</b>	ON-OFF / PID	ON-OFF	Autotune PID or ON - OFF
<b>CONTROL OUTPUT</b>	Relay : SPDT : 10A resistive @ 250V AC / 30V DC	Relay : SPST : 10A resistive @ 250V AC / 30V DC	Relay : SPDT : 10A resistive @ 250V AC / 30V DC or SSR : 12V DC, 30mA
<b>AUXILIARY OUTPUT</b>	---		Relay : SPDT : 5A resistive @ 250V AC / 30V DC
<b>SUPPLY VOLTAGE (AC: 50 / 60 Hz)</b>	90 to 270V AC / DC		



**PID500-T**  
48(H) x 48(W) x 100(D)mm



**PID500**  
48(H) x 48(W) x 100(D)mm



**PID110**  
96(H) x 48(W) x 74.5(D)mm



**PID330**  
96(H) x 96(W) x 74.5(D)mm



**PID528**  
48(H) x 48(W) x 100(D)mm

<b>FEATURES</b>	<ul style="list-style-type: none"> <li>TC / RTD input</li> <li>Single step ramp soak</li> <li>Max 3 outputs</li> <li>Retransmission (Optional)</li> </ul>	<ul style="list-style-type: none"> <li>Advanced PID control</li> <li>Universal input</li> <li>Single step ramp soak</li> <li>Max 3 outputs</li> <li>Retransmission (Optional)</li> <li>RS485 MODBUS RTU protocol (Optional)</li> </ul>	<ul style="list-style-type: none"> <li>Dual display, Dual set point</li> <li>TC / RTD input</li> <li>Control output : Relay</li> <li>Auxiliary output : Relay</li> </ul>
<b>DISPLAY</b>	4 + 4 digits, 7 segment LED dual display		
<b>INPUT TYPE</b>	Thermocouple : J, K, T, R, S, C, E, B, N, L, U, W, Platinel II RTD : PT100	Thermocouple : J, K, T, R, S, C, E, B, N, L, U, W, Platinel II RTD : PT100 Signal inputs (DC) : -5 to 56 mV, 0 to 10 V DC, 0 to 20 mA DC	Thermocouple (J, K, T, R, S) / RTD (PT100)
<b>RESOLUTION</b>	TC / RTD : 1 / 0.1°	TC / RTD : 1 / 0.1°; Analog input : 1 / 0.1 / 0.01 / 0.001	0.1 / 1° for TC / RTD inputs (Fixed 1° for R & S type TC input)
<b>ACCURACY</b>	For TC input : 0.25% of F.S. ±1°; For R & S inputs : 0.5% of F.S. ±2° (20 min of warm up time); For RTD input : 0.1% of F.S. ±1°; Signal input : ±0.5%, ± 1 digit (Except PID500-T)		For TC Inputs : 0.25% of F.S. ±1°; For R & S Inputs : 0.5% of F.S. ±2° (20 min of warm up time); For RTD Input : 0.1% of F.S. ±1°
<b>SET POINT</b>	Maximum 3		Dual set point
<b>CONTROL MODE</b>	Autotune PID or ON - OFF		
<b>CONTROL OUTPUT</b>	Relay : SPST : 5A @ 250V AC / 30V DC or SSR : 12V DC, 20mA or Current : 4 to 20 mA DC (Max load 500E) or Voltage : 0 to 10V DC (Min load 10K) (Depends on product code selection)		Relay : SPST : 5A resistive @ 250V AC / 30V DC
<b>AUXILIARY OUTPUT</b>	(Maximum 2) Relay or SSR (Mode : Set point or alarm mode) Relay : SPST : 5A @ 250V AC / 30V DC; SSR : 12V DC, 20mA		Relay : SPST : 5A resistive @ 250V AC / 30V DC
<b>OPTIONAL FEATURES</b>	---	Extra alarm output, Retransmission analog output, RS485 MODBUS RTU protocol	---
<b>SUPPLY VOLTAGE</b> (AC : 50 / 60 Hz)	90 to 270V AC / DC		

## Universal PID Controller



**PID500-U**  
48(H) x 48(W) x 84(D)mm

<b>FEATURES</b>	<ul style="list-style-type: none"> <li>White + Green Dual Display</li> <li>Capacitive Touch Keypad</li> <li>Compact Size with Short Depth</li> <li>Universal input, Universal output</li> <li>Adaptive Tune PID control</li> <li>Profile controller up to 128 steps</li> <li>RS485 MODBUS RTU protocol (Optional)</li> <li>IDM applicable</li> </ul>
<b>DISPLAY</b>	4 + 4 digits, 7 segment LED dual display
<b>INPUT TYPE</b>	Thermocouple : J, K, T, R, S, C, E, B, N, L, U, W, Platinel II RTD : PT100 Signal inputs (DC) : -5 to 56 mV, 0 to 5/10 V DC, 0/4 to 20 mA DC
<b>RESOLUTION</b>	TC / RTD : 1 / 0.1 Analog input : 1 / 0.1 / 0.01 / 0.001
<b>ACCURACY</b>	For TC input : 0.25% of F.S. ±1°; For R & S inputs : 0.5% of F.S. ±2° (20 min of warm up time); For RTD input : 0.1% of F.S. ±1°; Signal input : ±0.5%, ± 1 digit
<b>SET POINT</b>	3 Set Point
<b>CONTROL MODE</b>	Autotune PID or ON - OFF
<b>CONTROL OUTPUT</b>	Relay : SPST : 5A @ 250V AC / 30V DC SSR : 12V DC, 20mA Current : 4 to 20 mA DC (Max load 500E) Voltage : 0 to 10V DC (Min load 10K)
<b>AUXILIARY OUTPUT</b>	2 X Relay : SPST : 5A @ 250V AC / 30V DC
<b>OPTIONAL FEATURES</b>	Extra alarm output, Retransmission analog output, RS485 MODBUS RTU protocol, IDM applicable
<b>SUPPLY VOLTAGE</b> (AC : 50 / 60 Hz)	90 to 270V AC / DC

## Independent Downloader Module



- Easy programming
- Compact size
- LED indication

<b>RATED SUPPLY VOLTAGE</b>	1.8V DC to 5.5V DC
<b>UPLOADING TIME</b>	1 Sec
<b>DOWNLOADING TIME</b>	1 Sec



## Humidity Controllers



<b>FEATURES</b>	<ul style="list-style-type: none"> <li>• Single display</li> <li>• RH sensor input</li> <li>• ON-OFF control</li> <li>• Compact size</li> <li>• Relay control output</li> <li>• Alarm relay output</li> </ul>	<ul style="list-style-type: none"> <li>• Dual display</li> <li>• RH sensor input</li> <li>• ON-OFF control</li> <li>• Relay control output</li> <li>• Alarm relay output</li> </ul>
<b>DISPLAY</b>	3 Digit LED White Display	
<b>INPUT TYPE</b>	5V RH sensor Input for Humidity	
<b>RESOLUTION</b>	0 / 0.1	
<b>ACCURACY</b>	Humidity: $\pm 1\%$ of Full scale	
<b>SET POINT</b>	1	
<b>CONTROL MODE</b>	ON-OFF control	
<b>CONTROL OUTPUT</b>	10A@250V AC/ 30V DC SPDT relay Output	
<b>AUXILIARY OUTPUT</b>	5A SPDT Relay output	10A@250V AC SPDT relay Output
<b>OPTIONAL FEATURES</b>	Load protection protocol, Low / High Alarm, Free RH Sensor with unit	
<b>SUPPLY VOLTAGE</b> (AC : 50 / 60 Hz)	90 to 270V AC/DC	

## Humidity+Temperature Controllers



<b>FEATURES</b>	<ul style="list-style-type: none"> <li>• Single display</li> <li>• RH + RTD sensor input</li> <li>• ON-OFF control for Humidity</li> <li>• PID control for Temperature</li> <li>• Compact Size</li> <li>• 2 relay control output</li> </ul>	<ul style="list-style-type: none"> <li>• Dual display</li> <li>• RH + RTD input</li> <li>• ON-OFF control for Humidity</li> <li>• PID control for Temperature</li> <li>• 2 relay control output</li> </ul>
<b>DISPLAY</b>	3 Digit LED White Display	
<b>INPUT TYPE</b>	5V RH sensor Input for Humidity, RTD: PT100 Sensor input for temperature	
<b>RESOLUTION</b>	0 / 0.1	
<b>ACCURACY</b>	Humidity: $\pm 1\%$ of Full scale, RTD: 0.1% of full scale	
<b>SET POINT</b>	2	
<b>CONTROL MODE</b>	For Humidity: ON-OFF control , For Temperature: Auto tune PID / ON-OFF control	
<b>CONTROL OUTPUT</b>	For Humidity: 7A@250V AC SPDT Relay, For Temperature: 7A@250V AC SPDT Relay	
<b>OPTIONAL FEATURES</b>	Load protection protocol, Low / High Alarm, Free RH Sensor with unit	
<b>SUPPLY VOLTAGE</b> (AC : 50 / 60 Hz)	90 to 270V AC / DC	

## Accessories



ADAPTER PLATES-72 x 48



ADAPTER PLATES-96 x 48



ADAPTER PLATES-96 x 72



SNUBBER

<b>DESCRIPTION</b>	To assemble 48 x 48mm size product in to 72 x 72mm Panel cutout	To assemble 48 x 48mm size product in to 96 x 96mm Panel cutout	To assemble 72 x 72mm size product in to 96 x 96mm Panel cutout	To increase internal relay protection of the product
--------------------	---	---	---	--

## Cooling Controllers



**CH403B**  
36(H) x 72(W) x 65.3(D)mm



**CH403C**  
36(H) x 72(W) x 65.3(D)mm

<b>FEATURES</b>	<ul style="list-style-type: none"> <li>• 2½ Digits single display</li> <li>• NTC input type</li> <li>• Restart time delay</li> <li>• Auto / Manual defrost selection</li> <li>• Door open mode</li> <li>• Cyclic timer (Optional)</li> </ul>	<ul style="list-style-type: none"> <li>• 3 Digits single display</li> <li>• Capacitive touch keypad</li> <li>• Defrost management</li> <li>• IDM applicable</li> <li>• Compact size</li> </ul>
<b>DISPLAY</b>	2½ digits, 7 segment display	
<b>INPUT TYPE</b>	NTC type sensor	
<b>RESOLUTION</b>	1 / 0.1°	
<b>ACCURACY</b>	±1% of F.S.	
<b>SETPOINT</b>	Single set point	
<b>CONTROL MODE</b>	ON - OFF	
<b>CONTROL OUTPUT</b>	SPDT: 10A @ 250V AC / 30V DC or SPST/ LUG Type : 20A @ 250V AC / 30V DC (Depends on product code selection)	SPDT: 10A @ 250V AC / 30V DC or SPST/ LUG Type : 20A @ 250V AC / 30V DC (Depends on product code selection)
<b>AUXILIARY OUTPUT</b>	SSR: 12V DC, 10mA or Relay: SPST: 5A @ 230V AC / 30V DC (Depends on product code selection)	---
<b>HYSTERESIS</b>	0.1 to 9.9°	
<b>DISPLAY OFFSET</b>	-19.9° to 19.9°	-19.9° to 20.0°
<b>RESTART TIME DELAY</b>	Adjustable from 0 to 19.9 min	Adjustable from 0 to 99 min
<b>RELAY ACTION</b>	Heat & Cool mode	
<b>DEFROST TIME</b>	Programmable from 0 to 99 min	
<b>DEFROST FREQUENCY</b>	Programmable from 0 to 99 (hr / min / sec)	
<b>SUPPLY VOLTAGE</b> (AC : 50 / 60 Hz)	230V AC	

## Process Indicators



**PIC152A-VI**  
48(H) x 96(W) x 76(D)mm



**PIC101N**  
48(H) x 96(W) x 76(D)mm



**PIC101A-T-230**  
48(H) x 96(W) x 76(D)mm



**PIC101A-VI-230**  
48(H) x 96(W) x 76(D)mm

<b>FEATURES</b>	<ul style="list-style-type: none"> <li>• User programmable universal input</li> <li>• Retransmission output</li> <li>• LED status indicator : Alarm ON</li> <li>• 2 Alarm indication</li> <li>• Inbuilt 24V DC sensor supply</li> </ul>	<ul style="list-style-type: none"> <li>• 4 digits, Single display</li> <li>• User programmable universal input</li> <li>• Scalable voltage / current input</li> </ul>	<ul style="list-style-type: none"> <li>• Simple temperature indicator</li> <li>• TC / RTD input type</li> </ul>	<ul style="list-style-type: none"> <li>• 4 Digits single display</li> <li>• User programmable voltage &amp; current input</li> </ul>
<b>DISPLAY</b>	4 digits, 7 segment LED single display			
<b>INPUT TYPE</b>	Thermocouple : J, K, T, R, S, RTD : PT100 Signal inputs (DC) : -5 to 56mV, 0 to 10V, 0/4 to 20mA		Thermocouple : J, K, T, R, S RTD : PT100	
<b>RESOLUTION</b>	TC / RTD : 1 / 0.1, Analog input : 1 / 0.1 / 0.01 / 0.001		1 / 0.1° (Fix 1° resolution for R & S type TC)	
<b>ACCURACY</b>	For TC inputs : 0.25% of F.S. ±1°; For R & S inputs : 0.5% of F.S. ±2° (20 min of warm up time); For RTD input : 0.1% of F.S. ±1°; Cold junction accuracy ± 5°C ; Signal input : ±0.5% of F.S. ± 1 digit		For TC inputs : 0.25% of F.S. ±1°; For R & S input : 0.5% of F.S. ±2° (20 min of warm up time); RTD input : 0.1% of F.S. ±1°	
<b>OUTPUT</b>	2 Alarms : SPDT : 5A @ 250V AC / 24V DC	Alarm modes : High, Low, Band, Fail output & fault diagnosis. Hysteresis, Annunciator : Programmable, Reset action : Automatic or latched	---	---
<b>SPECIAL FEATURES</b>	Retransmission output : 0 / 4 to 20mA DC, 0 to 5V DC, 0 to 5 / 10V DC, (Software selectable) RS485 MODBUS RTU protocol (Optional)		---	---
<b>SENSOR SUPPLY</b>	24V DC, 30mA (Output to power the sensor)		---	
<b>SUPPLY VOLTAGE</b> (AC : 50 / 60 Hz)	90 to 270V AC / DC, 24V DC (Optional)		230V AC, ±20%	

## DC to AC - Solid State Relay



**RSS-TD1A125ZP**  
58(H) x 45(W)  
x 27.3(D)mm



**RSS-TD1A140ZP**  
58(H) x 45(W)  
x 27.3(D)mm



**RSS-TD1A225ZP**  
58(H) x 45(W)  
x 27.3(D)mm



**RSS-TD1A240ZP**  
58(H) x 45(W)  
x 27.3(D)mm



**RSS-TD1A225ZPL**  
58(H) x 45(W)  
x 27.3(D)mm



**RSS-TD1A240ZPL**  
58(H) x 45(W)  
x 27.3(D)mm

<b>FEATURES</b>	<ul style="list-style-type: none"> <li>Resistive Output Load</li> <li>Compact Size</li> <li>Zero Cross Switching</li> <li>For Resistive + Slightly Inductive load</li> </ul>			<ul style="list-style-type: none"> <li>Resistive + Inductive Output Load</li> <li>Compact Size</li> <li>Zero Cross Switching</li> <li>For Resistive + Inductive load</li> </ul>		
<b>CONTROL INPUT VOLTAGE</b>	4 to 32V DC					
<b>LOAD OUTPUT VOLTAGE</b>	24 to 330V AC			48 to 480V AC		
<b>MAX LOAD CURRENT</b>	25A	40A	25A	40A	25A	40A
<b>CONTACT CONFIGURATION</b>	1 NO					
<b>OUTPUT DEVICE</b>	TRIAC					

## DC to AC - Solid State Relay



**RSS-SD1A290ZPL**  
58(H) x 46.75(W)  
x 41(D)mm



**RSS-SD1A2125ZPL**  
58(H) x 46.75(W)  
x 41(D)mm



**RSS-TA1A125ZP**  
58(H) x 45(W)  
x 27.3(D)mm



**RSS-TA1A140ZP**  
58(H) x 45(W)  
x 27.3(D)mm



**RSS-TA1A225ZP**  
58(H) x 45(W)  
x 27.3(D)mm



**RSS-TA1A240ZP**  
58(H) x 45(W)  
x 27.3(D)mm

<b>FEATURES</b>	<ul style="list-style-type: none"> <li>Resistive + Inductive Output Load</li> <li>Compact Size</li> <li>Zero Cross Switching</li> <li>For Resistive + Inductive load</li> </ul>			<ul style="list-style-type: none"> <li>Resistive Output Load</li> <li>Compact Size</li> <li>Zero Cross Switching</li> <li>For Resistive + Slightly Inductive load</li> </ul>		
<b>CONTROL INPUT VOLTAGE</b>	4 to 32V DC			90 to 280V AC		
<b>LOAD OUTPUT VOLTAGE</b>	48 to 480V AC			24 to 330V AC		48 to 480V AC
<b>MAX LOAD CURRENT</b>	90A	125A	25A	40A	25A	40A
<b>CONTACT CONFIGURATION</b>	1 NO					
<b>OUTPUT DEVICE</b>	SCR's			TRIAC		

## AC to AC - Solid State Relay

### Ordering information

#### Temperature Controllers

PRODUCT CODE	OUTPUT 1		OUTPUT 2	SUPPLY VOLTAGE	CERTIFICATION
	RELAY	SSR			
TC544C	RELAY (5A)	SSR (12V DC)	RELAY (5A)	90 to 270V AC / DC	CE
TC244CX	RELAY (5A)	SSR (12V DC)	RELAY (5A)	90 to 270V AC / DC	---
TC344CX	RELAY (5A)	SSR (12V DC)	RELAY (5A)	90 to 270V AC / DC	---
TC513CX	RELAY (10A)	SSR (12V DC)	---	90 to 270V AC / DC	---
TC203CX	RELAY (10A)	SSR (12V DC)	---	90 to 270V AC / DC	---
TC303CX	RELAY (10A)	SSR (12V DC)	---	90 to 270V AC / DC	---
TC538CX	RELAY (10A)	SSR (12V DC)	---	90 to 270V AC / DC	---
TC544B	RELAY (5A)	SSR (12V DC)	RELAY (5A)	90 to 270V AC / DC	---
TC544B-CE	RELAY (5A)	SSR (12V DC)	RELAY (5A)	90 to 270V AC / DC	CE
TC513BX	RELAY (10A)	SSR (12V DC)	---	90 to 270V AC / DC	---
TC513BX-CE	RELAY (10A)	SSR (12V DC)	---	90 to 270V AC / DC	CE
TC533BX	RELAY (10A)	SSR (12V DC)	---	90 to 270V AC / DC	---
TC533BX-CE	RELAY (10A)	SSR (12V DC)	---	90 to 270V AC / DC	CE
TC538BX	RELAY (10A)	SSR (12V DC)	---	90 to 270V AC / DC	---

## Ordering information

### Temperature Controllers

PRODUCT CODE	OUTPUT 1		OUTPUT 2	SUPPLY VOLTAGE	CERTIFICATION
	RELAY	SSR			
TC544A	RELAY (5A)	SSR (12V DC)	RELAY (5A)	90 to 270V AC / DC	---
TC544A-24V	RELAY (5A)	SSR (12V DC)	RELAY (5A)	24V DC	CE
TC544A-CU	RELAY (5A)	SSR (12V DC)	RELAY (5A)	90 to 270V AC / DC	CE <sup>EN 61010</sup>
TC244AX	RELAY (5A)	SSR (12V DC)	RELAY (5A)	90 to 270V AC / DC	---
TC344AX	RELAY (5A)	SSR (12V DC)	RELAY (5A)	90 to 270V AC / DC	---
TC513AX	RELAY (10A)	SSR (12V DC)	---	90 to 270V AC / DC	---
TC513AX-CU	RELAY (10A)	SSR (12V DC)	---	90 to 270V AC / DC	CE <sup>EN 61010</sup>
TC513AX-24V	RELAY (10A)	SSR (12V DC)	---	24V DC	CE
TC533AX	RELAY (10A)	SSR (12V DC)	---	90 to 270V AC / DC	---
TC203AX	RELAY (10A)	SSR (12V DC)	---	90 to 270V AC / DC	---
TC303AX	RELAY (10A)	SSR (12V DC)	---	90 to 270V AC / DC	---
TC303A	RELAY (10A)	SSR (12V DC)	---	90 to 270V AC / DC	---
DTC503	RELAY (10A)	---	---	90 to 270V AC / DC	---
DTC231	RELAY (10A)	---	---	90 to 270V AC / DC	---
DTC331	RELAY (10A)	---	---	90 to 270V AC / DC	---
DTC204A-2	RELAY (10A)	SSR (12V DC)	RELAY (5A)	90 to 270V AC / DC	---
DTC324A-2	RELAY (10A)	SSR (12V DC)	RELAY (5A)	90 to 270V AC / DC	---
IDM	---	---	---	---	---

### PID Controllers

PRODUCT CODE	OUTPUT 1	OUTPUT 2	OUTPUT 3	COMM. (RS485)	SUPPLY VOLTAGE	CERTIFICATION
PID500-U-C-1	UNIVERSAL	RELAY (7A)	RELAY (10A)	YES	90 to 270V AC / DC	CE
PID500-U-0-1	UNIVERSAL	RELAY (7A)	RELAY (10A)	---	90 to 270V AC / DC	CE
PID500-T-0-0-01	RELAY (5A)	RELAY (5A)	RELAY (5A)	---	90 to 270V AC / DC	---
PID500-T-1-0-01	SSR (12V DC)	RELAY (5A)	RELAY (5A)	---	90 to 270V AC / DC	---
PID500-T-2-0-01	4-20mA	RELAY (5A)	RELAY (5A)	---	90 to 270V AC / DC	---
PID500-2-0-04	4-20mA	RELAY (5A)	RELAY (5A)	YES	90 to 270V AC / DC	---
PID500-2-0-04 V2-CE	4-20mA	RELAY (5A)	RELAY (5A)	YES	90 to 270V AC / DC	CE
PID500-3-0-00	0 - 10V	RELAY (5A)	---	---	90 to 270V AC / DC	---
PID500-3-0-00 V2-CE	0 - 10V	RELAY (5A)	---	---	90 to 270V AC / DC	CE
PID500-0-0-01 V2-CE	RELAY (5A)	RELAY (5A)	RELAY (5A)	---	90 to 270V AC / DC	CE
PID500-0-0-01	RELAY (5A)	RELAY (5A)	RELAY (5A)	---	90 to 270V AC / DC	---
PID500-0-0-04	RELAY (5A)	RELAY (5A)	RELAY (5A)	YES	90 to 270V AC / DC	---
PID500-0-0-04 V2-CE	RELAY (5A)	RELAY (5A)	RELAY (5A)	YES	90 to 270V AC / DC	CE
PID500-2-0-01	4-20mA	RELAY (5A)	RELAY (5A)	---	90 to 270V AC / DC	---
PID500-2-0-01 V2-CE	4-20mA	RELAY (5A)	RELAY (5A)	---	90 to 270V AC / DC	CE
PID500-1-0-01	SSR (12V DC)	RELAY (5A)	RELAY (5A)	---	90 to 270V AC / DC	---
PID500-1-0-01 V2-CE	SSR (12V DC)	RELAY (5A)	RELAY (5A)	---	90 to 270V AC / DC	CE
PID500-1-0-00	SSR (12V DC)	RELAY (5A)	---	---	90 to 270V AC / DC	---
PID500-1-0-00 V2-CE	SSR (12V DC)	RELAY (5A)	---	---	90 to 270V AC / DC	CE
PID330-2-0-04	4-20mA	RELAY (5A)	RELAY (5A)	YES	90 to 270V AC / DC	---
PID330-0-0-01	RELAY (5A)	RELAY (5A)	RELAY (5A)	---	90 to 270V AC / DC	---
PID110-2-0-04	4-20mA	RELAY (5A)	RELAY (5A)	YES	90 to 270V AC / DC	---
PID110-0-0-01	RELAY (5A)	RELAY (5A)	RELAY (5A)	---	90 to 270V AC / DC	---
PID528-1	RELAY (5A)	RELAY (5A)	---	---	90 to 270V AC / DC	---
PID528-1 V2-CE	RELAY (5A)	RELAY (5A)	---	---	90 to 270V AC / DC	CE

### Humidity & Temperature Controllers

PRODUCT CODE	INPUT	CONTROL OUTPUT		AUXILIARY OUTPUT	SUPPLY VOLTAGE	CERTIFICATION
		OUTPUT 1	OUTPUT 2			
HC404	RH	RELAY (10A)	---	RELAY (5A)	90 to 270V AC / DC	CE
HC205	RH	RELAY (10A)	---	RELAY (10A)	90 to 270V AC / DC	---
HTC405	RH + RTD	RELAY (7A)	RELAY (7A)	---	90 to 270V AC / DC	CE
HTC206	RH + RTD	RELAY (10A) / SSR (12V)	RELAY (10A)	---	90 to 270V AC / DC	---

## Ordering information

### Cooling Controllers

PRODUCT CODE	OUTPUT		SUPPLY VOLTAGE	CERTIFICATION
	CONTROL OUTPUT	ALARM OUTPUT		
CH403B-1-NTC	RELAY (10A)	---	90 to 270V AC / DC	---
CH403B-2-NTC	RELAY (20A LUG Type)	---	90 to 270V AC / DC	---
CH403B-3-NTC	RELAY (20A)	RELAY (5A)	90 to 270V AC / DC	---
CH403C-1-NTC V2	RELAY (10A)	SSR (12V)	90 to 270V AC / DC	CE
CH403C-2-NTC	RELAY (20A LUG Type)	---	90 to 270V AC / DC	CE
CH403C-3-NTC	RELAY (10A)	RELAY (5A)	90 to 270V AC / DC	CE

### Process Indicators

PRODUCT CODE	RETRANSMISSION	COMM. (RS485)	SUPPLY VOLTAGE	CERTIFICATION
PIC152A-VI	YES	---	90 to 270V AC / DC	---
PIC152A-VI-CE	YES	---	90 to 270V AC / DC	CE
PIC152A-VI-C-24V	YES	YES	24V DC	---
PIC101-N	---	---	90 to 270V AC / DC	CE
PIC101N-24V	---	---	24V DC	CE
PIC101N-CU	---	---	90 to 270V AC / DC	CE, RoHS
PIC101A-T-230	---	---	230V AC	---
PIC101A-VI-230	---	---	230V AC	---

### Solid State Relay

#### Nomenclature

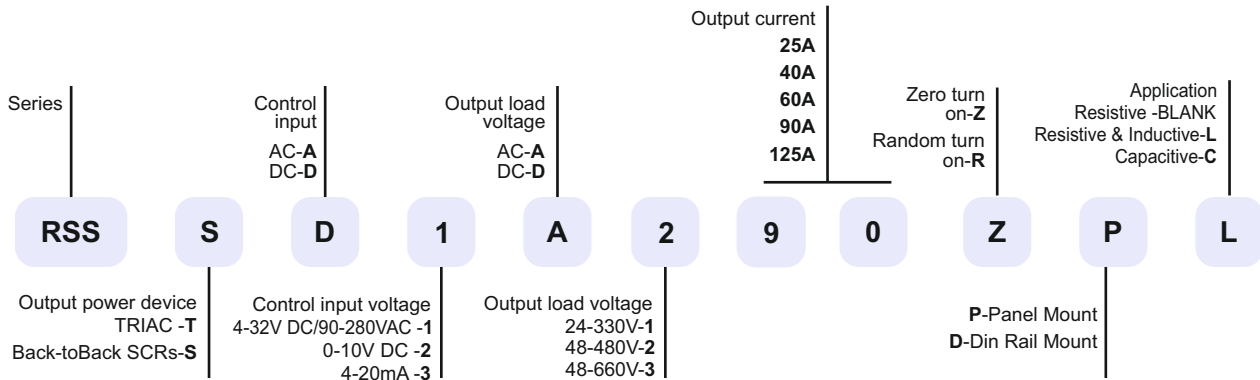

PRODUCT CODE	CURRENT RATINGS	CONTROL INPUT VOLTAGE	LOAD OUTPUT VOLTAGE	CERTIFICATION
RSS-TD1A125ZP	25	4 to 32V DC	24 to 330V AC	CE
RSS-TD1A140ZP	40	4 to 32V DC	24 to 330V AC	CE
RSS-TD1A225ZP	25	4 to 32V DC	48 to 480V AC	CE
RSS-TD1A240ZP	40	4 to 32V DC	48 to 480V AC	CE
RSS-TA1A125ZP	25	90 to 280V AC	24 to 330V AC	CE
RSS-TA1A140ZP	40	90 to 280V AC	24 to 330V AC	CE
RSS-TA1A225ZP	25	90 to 280V AC	48 to 480V AC	CE
RSS-TA1A240ZP	40	90 to 280V AC	48 to 480V AC	CE
RSS-TD1A225ZPL	25	4 to 32V DC	48 to 480V AC	CE
RSS-TD1A240ZPL	40	4 to 32V DC	48 to 480V AC	CE
RSS-SD1A290ZPL	90	4 to 32V DC	48 to 480V AC	CE
RSS-SD1A2125ZPL	125	4 to 32V DC	48 to 480V AC	CE

### Accessories

PRODUCT CODE	PRODUCT SIZE	INTERNAL CUTOUT SIZE
ADAPTER PLATES 72x48 (FG)	72 x 72mm	48 x 48mm
ADAPTER PLATES 96x48 (FG)	96 x 96mm	48 x 48mm
ADAPTER PLATES 96x72 (FG)	96 x 96mm	72 x 72mm
SNUBBER	---	---



**2M**  
90(H) x 35(W) x 60(D)mm



**4M**  
90(H) x 70(W) x 66.4(D)mm



**6M**  
90(H) x 105(W) x 66.4(D)mm

<b>FEATURES</b>	<ul style="list-style-type: none"> <li>• Modular PLC with pluggable display</li> <li>• RTC with time switch functions (Optional)</li> <li>• Flexible IO card selection</li> </ul>		<ul style="list-style-type: none"> <li>• Modular PLC with pluggable display</li> <li>• Flexible IO card selection</li> <li>• Expandable</li> <li>• RTC with time switch functions</li> </ul>		<ul style="list-style-type: none"> <li>• Modular PLC with pluggable display</li> <li>• Flexible IO card selection</li> <li>• Expandable</li> <li>• RTC with time switch functions</li> </ul>	
<b>DISPLAY TYPE</b>	7 Segment LED		LCD with green backlight & black font	7 Segment LED		LCD with green backlight & black font
<b>DIGITS</b>	4 Red	1 Red	2 lines x 8 characters (Font size 5x7mm)	1 Red	2 lines x 8 characters (Font size 5x7mm)	
<b>LED BANKS</b>	6 Red LED		---	6 Red LED		---
<b>NO. OF KEYS</b>	3 Keys (2 User configurable)		5 keys (4 User configurable)	1 key	6 keys (5 User configurable)	
<b>NO. OF SLOTS</b>	2		4		6	
<b>SUPPLY VOLTAGE</b>	18 to 30V AC	18 to 30V DC	100 to 270V AC	18 to 30V DC	100 to 270V AC	18 to 30V DC
<b>DIGITAL INPUTS</b>	3		4 + 1*		10 + 1*	12
<b>INPUT TYPE &amp; RANGE</b>	PNP (5-30V)					
<b>FAST INPUT</b>	1					2
<b>MAXIMUM COUNTING FREQUENCY</b>	5kHz (PNP)					
<b>ANALOG INPUT</b>	As per Slot I/O card		1 ( Voltage 0-10V)			
<b>RESOLUTION</b>	As per Slot I/O card		12 BIT			
<b>DIGITAL OUTPUT</b>	As per Slot I/O card				4 Relay	As per Slot I/O card
<b>TYPE AND RATING</b>	As per Slot I/O card				5A NO Type@ 250VAC/30VDC	As per Slot I/O card
<b>COMMUNICATION INTERFACE</b>	RS485 Modbus RTU Protocol (Slave )		RS485 Modbus RTU Protocol (Master - Slave )			RS485 Modbus RTU- Protocol (Master - Slave), ETHERNET (Slave), USB (Slave)
<b>PROGRAM MEMORY</b>	112 Kb		240 Kb			480 Kb
<b>RTC</b>	Optional		Yes			

**PLUGGABLE DISPLAY MODULES**



MiBRX-DSP-2M-7-1-04-A



MiBRX-DSP-2M-0-1-06-A



MiBRX-DSP-4M-8-2-08-A



MiBRX-DSP-4M-0-1-06-A



MiBRX-DSP-6M-8-2-08-A

\*Digital input can be configured as analog input (0-10V)

## MiBRX Series - Panel Mount



48 x 96  
48(H) x 96(W) x 69(D)mm



72 x 72  
72(H) x 72(W) x 71.35(D)mm



96 x 96  
96(H) x 96(W) x 99.1(D)mm

<b>FEATURES</b>	<ul style="list-style-type: none"> <li>Modular PLC with pluggable display</li> <li>RTC with time switch functions (Optional)</li> <li>Flexible IO card selection</li> </ul>		<ul style="list-style-type: none"> <li>Modular PLC with pluggable display</li> <li>Flexible IO card selection</li> <li>RTC with time switch functions</li> </ul>		<ul style="list-style-type: none"> <li>Modular PLC with pluggable display</li> <li>Flexible card selections</li> <li>Expandable</li> <li>RTC with time switch functions</li> </ul>	
<b>DISPLAY TYPE</b>	7 Segment LED		LCD with blue backlight & black font	7 Segment LED-White+Green	LCD with Green backlight	LCD with White backlight
<b>DIGITS</b>	(3 + 4) Red + 4 Green	(4 + 4) Red + 6 Green	2 lines x 8 characters (Font size 5x7mm)	6 White + 4 Green	4 lines x 16 characters (Font side 5x7mm)	Customized segments
<b>LED BANKS</b>	LED banks 6 Red round LEDs + 10 Red LEDs (Bar graph)	4 Red + 4 Green LED	---	4 Red	---	---
<b>NO. OF KEYS</b>	5 Touch keys (4 User configurable)		4 Touch keys (3 User configurable)		8 Touch keys (7 User configurable)	5 Touch keys (4 User configurable)
<b>NO. OF SLOTS</b>	2		2		6	
<b>SUPPLY VOLTAGE</b>	100 to 270V AC	18 to 30V DC	100 to 270V AC	18 to 30V DC	100 to 270V AC	18 to 30V DC
<b>DIGITAL INPUTS</b>	5 + 1*	5 + 2*	3 + 1*		3 + 1*	5 + 1*
<b>INPUT TYPE &amp; RANGE</b>	PNP (5-30V)					
<b>FAST INPUT</b>	1					
<b>MAXIMUM FREQUENCY</b>	5kHz (PNP)					
<b>ANALOG INPUT</b>	1 ( Voltage 0-10V)	3 ( 2 Voltage & 1 current 0-10V & 0-20mA)	1 ( Voltage 0-10V)	2 ( Voltage & Current 0-10V & 0-20mA)	1 ( Voltage 0-10V)	2 ( 1 Voltage & 1 Current 0-10V & 0-20mA)
<b>RESOLUTION</b>	12 BIT					
<b>DIGITAL OUTPUT</b>	As per Slot I/O card		3 Relay	4 Relay	As per Slot I/O card	
<b>TYPE AND RATING</b>	As per Slot I/O card		5A NO Type@ 250VAC/30VDC		As per Slot I/O card	
<b>COMMUNICATION INTERFACE</b>	RS485 Modbus RTU Protocol (Slave )				RS485 Modbus RTU Protocol (Master - Slave )	
<b>PROGRAM MEMORY</b>	240 Kb					
<b>RTC</b>	Optional			Yes		
<b>SENSOR SOURCE</b>	24V, 50mA (230VAC Variant)					

**PLUGGABLE DISPLAY MODULES**



MiBRX-DSP-48-7-2-11-A



MiBRX-DSP-48-7-2-14-B



MiBRX-DSP-72-8-2-08-B



MiBRX-DSP-72-7-2-10-B



MiBRX-DSP-96-8-4-16-B

\*Digital input can be configured as analog input (0-10V)

## MiBRX Series - Independent Display



MiBRX-DSP-IND-96-8-0-00-C  
96(H) x 96(W) x 40(D)mm



MiBRX-DSP-IND-96-8-0-00-B  
96(H) x 96(W) x 40(D)mm



MiBRX-DSP-IND-96-8-4-16-B  
96(H) x 96(W) x 40(D)mm



MiBRX-DSP-IND-96-8-2-16-B  
96(H) x 96(W) x 40(D)mm

<b>FEATURES</b>	<ul style="list-style-type: none"> <li>3.5" LCD Resistive touch screen</li> <li>10 password level</li> <li>RS485 MODBUS RTU, (Master-slave)</li> <li>In-built alarm</li> </ul>	<ul style="list-style-type: none"> <li>3.5" segment LCD</li> <li>Positive Mode</li> <li>White back light</li> <li>Black segments</li> </ul>	<ul style="list-style-type: none"> <li>16 columns and 4 rows</li> <li>Positive mode</li> <li>64 characters</li> <li>Yellow green backlight</li> <li>Black character</li> </ul>	<ul style="list-style-type: none"> <li>16 columns and 2 rows</li> <li>Positive mode</li> <li>32 characters</li> <li>Yellow green backlight</li> <li>Black character</li> </ul>
<b>DISPLAY TYPE</b>	3.5" LCD Resistive touch screen	3.5" segment LCD with backlight	16 columns and 4 rows LCD	16 columns and 2 rows LCD
<b>KEYS</b>	Yes ( 5 nos)		Yes ( 8 nos)	
<b>KEYS TYPE</b>	Capacitive Touch Pad type with integrated yellow green LEDs			
<b>SUPPLY VOLTAGE</b>	24 V DC (non-isolated)			

Independent display can be used only with MiBRX rail mount series with respective adapter plate & ACH-004 (6 Pin cable)

## Digital I/O specifications

## Digital input

	Input voltage range	Response time	Debounce time
MiBRX-SC-DI04* MiBRX-SC-DI06*	6-30V	Depends on debounce time & ladder execution time	10ms
MiBRX-SC-DI06-AC	6-30V AC	Depends on debounce time & ladder execution time	10ms

## Fast input

	Input type	Input frequency
MiBRX-SC-FI02	PNP / NPN (Jumper selectable)	10kHz

## Digital output

	Contact rating	Response time	Contact-Isolation
MiBRX-SC-RO03 MiBRX-SC-RO04 MiBRX-SC-RO05 MiBRX-SC-RO04-12V	5A 250VAC/30VDC	10ms	Yes

	Rated voltage	Output current	Response time	Isolation between outputs
MiBRX-SC-TO04	18V to 30V DC (External)	100mA	10ms	4kV

## Fast output

	Output type	Output frequency
MiBRX-SC-FO01-TO01	PNP / NPN (Terminal selectable)	10kHz

## Analog I/O specifications

## Analog inputs

	Analog type	Resolution	Conversion time	Accuracy
MiBRX-SC-AI02-I*	CURRENT (0-20mA)	12BIT	100ms	0.25%
MiBRX-SC-AI02-V*	VOLTAGE (0-10V)	12BIT	100ms	0.25%
MiBRX-SC-AI02-V-I	VOLTAGE (0-10V) & CURRENT (0-20mA)	12BIT	100ms	0.25%
MiBRX-SC-AI02-NTC	NTC	12BIT	100ms	0.25%
MiBRX-SC-AI02-PTC	PTC	12BIT	100ms	0.25%
MiBRX-SC-AI02-TC*	J, K, T, R, S, C, E, B, N, L, U, W, PLTNL, mVolt (-5 to 65mV), RTD (PT100)	12BIT	100ms	0.25%
MiBRX-SC-AI02-RTD*	RTD (PT100)	12BIT	100ms	0.25%
MiBRX-SC-AI02-PT1000	RTD (PT1000)	12BIT	100ms	0.25%
MiBRX-SC-LC02	Loadcell	24BIT	50ms to 400ms	...

## Analog output

	Output type	Resolution	Digital resolution	Conversion time
MiBRX-SC-AO01-V/I	VOLTAGE (0-10V) / CURRENT (0-20mA)	12BIT	0.0 to 100.0% = 0 to 10V / 0.0 to 100.0% = 0 to 20mA	100ms
MiBRX-SC-AO02-V-I-ISO	VOLTAGE (0-10V) & CURRENT (0-20mA)	12BIT	0.0 to 100.0% = 0 to 10V & 0.0 to 100.0% = 0 to 20mA	100ms

## Mixed - Digital Input &amp; Output

	Input voltage range	Response time	Debounce time	Contact rating	Response time	Contact-Isolation
MiBRX-SC-DI02-RO02 MiBRX-SC-DI02-RO03 MiBRX-SC-DI02-TO02	5-30V	Depends on debounce time & ladder execution time	10ms	5A 250VAC/30VDC	10ms	Yes

## Mixed - Digital &amp; Analog Input

	Rated voltage	Output current	Response time	Isolation between outputs	Analog type	Resolution	Conversion time	Accuracy
MiBRX-SC-DI02-AI01-T	18V to 30V DC (External)	100mA	10ms	4kV	J, K, T, R, S, C, E, B, N, L, U, W, PLTNL, mVolt (-5 to 65mV), RTD (PT100)	12BIT	100ms	0.25%

## Special Function

	Description
MiBRX-SC-DL	Datalogging (2MB) & RTC
MiBRX-SC-WIFI	WIFI
MiBRX-SC-PD	Portable Downloader

\* Also available in Isolated variant



## Flexys Series - Flexible IO PLC Solution



**FLEXYS GT35**  
99(H) x 99(W) x 110(D)mm

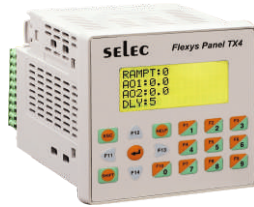

**FLEXYS PANEL TX4**  
99(H) x 99(W) x 110(D)mm



**FLEXYS RAIL**  
67(H) x 140(W) x 107(D)mm



**EXP FLEX 2M      EXP FLEX 2M V3**  
94(H) x 35(W) x 103(D)mm

<b>FEATURES</b>	<ul style="list-style-type: none"> <li>• 3.5" LCD with touch screen</li> <li>• Flexible I/O card selection</li> <li>• Real time clock</li> <li>• Expandable</li> </ul>	<ul style="list-style-type: none"> <li>• PLC with built in HMI</li> <li>• Flexible I/O card selection</li> <li>• Real time clock</li> <li>• Expandable</li> </ul>	<ul style="list-style-type: none"> <li>• PLC with flexible I/O card selection</li> <li>• Real time clock</li> <li>• Expandable</li> </ul>	<ul style="list-style-type: none"> <li>• Any flexys card can be configured</li> <li>• Selectable baudrate and slave ID</li> </ul>
<b>DISPLAY</b>	TFT 3.5" diagonal touch screen, Resolution 320x240	LCD with backlight, 4x16 character display, Font size 5x7mm	7 segment display for slot number & card status. Multipurpose LED bank	LED indication for power ON & communication status
<b>NO. OF KEYS</b>	5 function keys +1 system key	18 keys (14 user configurable)	One key to scroll through different slots	---
<b>I/Os</b>	3 I/O slots (Please refer I/O card for flexys series)	4 I/O slots (Please refer I/O card for flexys series)		---
<b>DIGITAL INPUTS</b>	4 / 10 /14 per card, PNP (6 - 30V DC)			
<b>MAXIMUM COUNTING FREQUENCY</b>	FC0 (I0 & I1) & FC1 (I2 & I3) - 5KHz (on power supply card only), Normal digital inputs - 30Hz			---
<b>ANALOG INPUTS</b>	3 / 4 / 6 Channels per card (TC, RTD, 0-10V, 0 - 20mA, NTC)			
<b>RESOLUTION</b>	12 Bits			
<b>RELAY OUTPUTS</b>	4 / 8 per card, NO type 5A @ 230V AC / 30V DC (Resistive)			
<b>TRANSISTOR OUTPUTS</b>	8 per card, Source type 100mA @ 24V DC			
<b>ANALOG OUTPUTS</b>	2 / 4 Channels per card (0 - 10V, 0 - 20mA)			
<b>RESOLUTION</b>	14 Bits (0.0 to 100.0% = 0 to 10.000V, 0.0 to 100.0% = 0 to 20.000mA)			
<b>PROGRAM MEMORY</b>	221KB	351KB		---
<b>EXPANSION</b>	Yes			
<b>COMMUNICATION INTERFACE</b>	RS485 MODBUS RTU protocol	RS485 MODBUS RTU, Proprietary protocol		RS485 MODBUS RTU, Proprietary protocol (Selec master PLC)      RS485 MODBUS RTU (Third party master PLC)
<b>RTC</b>	Yes			---
<b>BAUDRATE</b>	---			19200 / 115200 bps (Selectable)
<b>RESPONSE TIME</b>	---			100msec to 2sec + IO card Response
<b>SUPPLY VOLTAGE (AC : 50 / 60 Hz)</b>	18 - 30V DC, 100 - 240V AC			18 - 30V DC

## Compact Series - UNIX & TWIX



**UNIX-1**  
75.5(H) x 75.5(W) x 78(D)mm



**TWIX-1**  
50(H) x 98(W) x 78(D)mm

**TWIX-2**  
50(H) x 98(W) x 78(D)mm

**TWIX-3**  
50(H) x 98(W) x 78(D)mm

<b>FEATURES</b>	<ul style="list-style-type: none"> <li>• Compact PLC with built in HMI</li> <li>• RS485 MODBUS RTU protocol</li> </ul>	<ul style="list-style-type: none"> <li>• Compact PLC with built in HMI</li> <li>• Configurable LED display</li> <li>• RS485 MODBUS RTU protocol</li> </ul>		
<b>DISPLAY</b>	6 digits red & 4 green digits 7 segment LED	4 + 4 digits red & 6 green digits 7 segment LED		
<b>NO. OF KEYS</b>	3 keys (2 - User configurable)	5 keys (4 - User configurable)		
<b>DIGITAL INPUTS</b>	3 + 1*	6	6 + 2*	8
<b>INPUT TYPE</b>	PNP (5 - 30V DC)	PNP (6 - 30V DC)		
<b>MAXIMUM COUNTING FREQUENCY</b>	FC0 (I0 & I1) - 5KHz, Normal digital input: 30Hz			
<b>ANALOG INPUTS</b>	3 Channels, 1 (TC / RTD ), 1 (0-10V), 1(0-20mA)	1 Channel (TC / RTD)	6 Channels, 2 (TC / RTD ), 2 (0-10V), 2(0-20mA)	1 Channel (TC / RTD)
<b>ANALOG OUTPUTS</b>	---	---	1 Channel (0-10V/0-20mA)	---
<b>RESOLUTION</b>	12 Bits			
<b>DIGITAL OUTPUTS</b>	2 Relay, 2 Transistor	4 Relay	5 Relay	6 Transistor
<b>TYPE &amp; RATING</b>	For Relay O/P : 5A NO type @230V AC / 30V DC (Resistive), For Transistor O/P : Source type 100mA@24V DC			
<b>PROGRAM MEMORY</b>	240KB	112KB	240KB	112KB
<b>COMMUNICATION INTERFACE</b>	RS485 MODBUS RTU Protocol			
<b>SUPPLY VOLTAGE (AC : 50 / 60Hz)</b>	90 - 270V AC	90- 270V AC, 18-28 V DC		18 - 30V DC

## Compact Series - DIGIX



**DIGIX-1**      **DIGIX-1-1-1**  
94(H) x 70(W) x 67(D)mm



**DIGIX-1-B**  
90(H) x 70(W) x 67(D)mm



**DIGIX-2**  
90(H) x 70(W) x 67(D)mm



**DIGIX-4**  
90(H) x 70(W) x 67(D)mm

<b>FEATURES</b>	<ul style="list-style-type: none"> <li>• Compact PLC with built in HMI</li> <li>• 2 Line 8 character LCD</li> <li>• Real time clock**</li> <li>• RS485 MODBUS RTU protocol</li> </ul>		<ul style="list-style-type: none"> <li>• LED indications for input &amp; output</li> <li>• RS485 MODBUS RTU protocol</li> </ul>		<ul style="list-style-type: none"> <li>• Compact PLC with built in HMI</li> <li>• 2 Line 8 character LCD</li> <li>• Real time clock**</li> <li>• RS485 MODBUS RTU protocol</li> </ul>	
<b>DISPLAY</b>	2 X 8 Character LCD		LED indication for input, Output & communication status		2 X 8 Character LCD	
<b>NO. OF KEYS</b>	5 keys (4 - User configurable)		---		5 keys (4 - User configurable)	
<b>DIGITAL INPUTS</b>	8				10 + 2*	
<b>INPUT TYPE</b>	PNP (6 - 30V DC)					
<b>MAXIMUM COUNTING FREQUENCY</b>	FC0 (I0 & I1) - 5KHz, Normal digital input: 30Hz					
<b>ANALOG INPUTS</b>	---	Through expansion	---	2 Channels (0-10V)		Through expansion
<b>RESOLUTION</b>					12 Bits	
<b>DIGITAL OUTPUTS</b>	5 Relay				8 Relay	
<b>TYPE &amp; RATING</b>	5A NO type @230V AC / 30V DC (Resistive)					
<b>ANALOG OUTPUTS</b>					Through expansion	
<b>RESOLUTION</b>	---	As per expansion modules	---	As per expansion modules		
<b>RTC</b>	NO	YES	NO	NO	YES	
<b>EXPANSION</b>	NO	YES	NO	YES	YES	
<b>PROGRAM MEMORY</b>	112KB			240KB		
<b>COMMUNICATION INTERFACE</b>	RS485 Modbus RTU Protocol					
<b>SUPPLY VOLTAGE (AC : 50 / 60 Hz)</b>	18 - 30V DC**, 100 - 270V AC/DC	100 - 270V AC	18 - 30V DC			

\*Voltage Analog Inputs can be configured as Digital Inputs    \*\*Please refer Datasheet for exact Order code

## Compact Series - MM303X



**MM3030-4**  
110(H) x 99(W) x 62(D)mm



**MM3032-2-0-0-230V V2**      **MM3032-2-0-0-24V V2**  
110(H) x 99(W) x 62(D)mm      110(H) x 99(W) x 62(D)mm

<b>FEATURES</b>	<ul style="list-style-type: none"> <li>• Panel / DIN rail mounting</li> <li>• Fast inputs / outputs</li> <li>• Windows based user friendly software for ladder programming and HMI configuration</li> </ul>		<ul style="list-style-type: none"> <li>• Compact PLC with built-in HMI</li> <li>• Panel / DIN rail mounting</li> <li>• Windows based user friendly software for ladder programming and HMI configuration</li> </ul>	
<b>DISPLAY</b>	4x16 Character LCD		2x16 Character LCD	
<b>NO. OF KEYS</b>	15 keys (12 User configurable)		8 keys (6 User configurable)	
<b>DIGITAL INPUTS</b>	10 PNP (11 - 30V DC)		8 PNP (6 - 30V DC)	
<b>COUNTING FREQUENCY</b>	FC0 (I0 & I1) – 12KHz, FC1 (I2 & I3) & FC2 (I4 & I5) – 7.5KHz Normal input – 30Hz.		FC0 (I0 & I1) – 5KHz, Normal input – 30Hz.	
<b>ANALOG INPUTS</b>	2 Channel (0 - 10V or 0 to 20mA) selectable via jumpers		2 Channels (0 - 20mA) / (0-10V)      2 Channels (0 - 20mA / (0-10V) + 1 NTC Channel	
<b>RESOLUTION</b>	10 Bits		12 Bits	
<b>DIGITAL OUTPUTS</b>	8 Transistor		6 Relay	
<b>TYPE AND RATING</b>	O0-O1 Sink 50mA @ 24V DC (Fast Outputs 50KHz), O2-O7- Source 100mA @ 24V DC		5A NO type @ 230V AC / 30V DC (Resistive)	
<b>ANALOG OUTPUTS</b>	Through expansion		1 Channel, (0 - 10V)	
<b>RESOLUTION</b>	As per expansion modules		14 Bits (0.0% to 100.0% = 0 – 10.000V)	
<b>RTC</b>	YES		NO	
<b>EXPANSION</b>	YES		NO	
<b>PROGRAM MEMORY</b>	351KB		240KB	
<b>COMMUNICATION INTERFACE SLAVE</b>	RS485 MODBUS RTU protocol			
<b>COMMUNICATION INTERFACE MASTER</b>	RS485 MODBUS RTU protocol		---	
<b>SUPPLY VOLTAGE (AC : 50 / 60 Hz)</b>	18 - 30V DC		100-270V AC without retention 180-270V AC with retention	
			18 – 30V DC	

## Accessories - Relay Modules

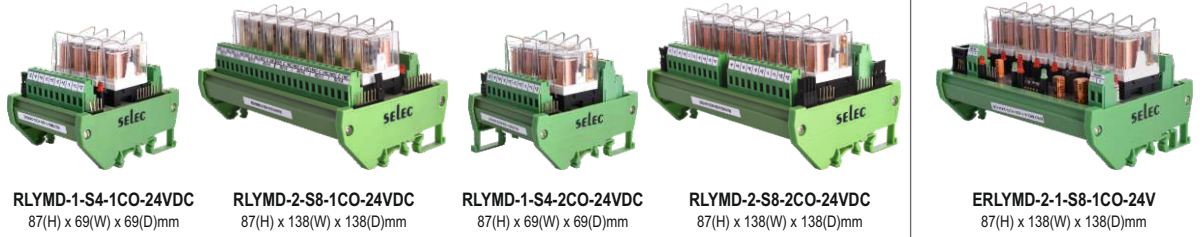

**RLYMD-1-S4-1CO-24VDC**  
87(H) x 69(W) x 69(D)mm

**RLYMD-2-S8-1CO-24VDC**  
87(H) x 138(W) x 138(D)mm

**RLYMD-1-S4-2CO-24VDC**  
87(H) x 69(W) x 69(D)mm

**RLYMD-2-S8-2CO-24VDC**  
87(H) x 138(W) x 138(D)mm

**ERLYMD-2-1-S8-1CO-24V**  
87(H) x 138(W) x 138(D)mm

<b>FEATURES</b>	<ul style="list-style-type: none"> <li>• LED and freewheeling diode across coils</li> <li>• Reverse polarity protection</li> <li>• Jumpers for coil looping</li> <li>• Pluggable relays</li> </ul>				<ul style="list-style-type: none"> <li>• RS485 Comm. over MODBUS-RTU</li> <li>• Selectable baudrate and slave ID</li> <li>• Pluggable relays</li> </ul>
<b>NO. OF CHANNELS</b>	4	8	4	8	8
<b>CONTACTS</b>	1 C / O		2 C / O		1 C / O
<b>CONTACT RATING</b>	10A @ 277V AC / 30V DC (Resistive)				
<b>NOMINAL VOLTAGE</b>	24V DC				
<b>MUST VOLTAGE</b>	18V DC				
<b>MAX VOLTAGE</b>	33V DC				
<b>OPERATE TIME</b>	15 msec				
<b>RESET TIME</b>	5 msec				
<b>COMMUNICATION PROTOCOL</b>	---				RS485 MODBUS RTU protocol
<b>STATUS DISPLAY</b>	LED indication for relay ON status				LED indication for relay ON status, Power ON & communication status
<b>SUPPLY VOLTAGE</b>	---				24V DC

## Accessories - Data Converters



**AC-RS485-RS232-ISO**



**AC-USB-RS232-01**



**AC-USB-RS485-02**



**AC-USB-RS485-03**



**AC-S2E-02**



**AC-S2W-01**

<b>FEATURES</b>	<ul style="list-style-type: none"> <li>• LED indication for communication status</li> <li>• Interface converter</li> </ul>	<ul style="list-style-type: none"> <li>• Port powered</li> <li>• Communication status available on LED Indication</li> </ul>	<ul style="list-style-type: none"> <li>• Web configuration telnet protocol</li> <li>• TCP / IP protocol</li> </ul>	<ul style="list-style-type: none"> <li>• Web based configuration utility</li> <li>• MQTT protocol</li> </ul>
<b>DISPLAY</b>	LED indication for power on, Tx & Rx	LED indication for Tx & Rx	LED indication for power ON, Tx, Rx, & Reset switch	LED indication for power ON, Tx, Rx, & Network
<b>INTERFACE 1</b>	Serial (RS485 MODBUS RTU protocol)	USB 2.0 compliance	Serial (RS485 MODBUS RTU protocol)	
<b>CONNECTOR</b>	2 wire	USB type A	2 wire (Data+, Data-)	
<b>INTERFACE 2</b>	Serial (RS232 MODBUS RTU protocol)	Serial (RS485 MODBUS RTU protocol)	Ethernet (TCP / IP, Telnet)	Wi-Fi, MQTT protocol
<b>CONNECTOR</b>	DB9	2 wire open	RJ 45 (8 Pin)	Wireless
<b>TRANSMISSION SPEED</b>	2400 to 115200 bps	2400 to 115200 bps	RS485 : 300 to 115000 bps Ethernet : 10 / 100 Mbps	801.1 a/g : 65, 54, 48, 36, 24, 18, 12, 9, 6 Mbps, Auto rate 802.11b : 11, 5.5, 2, 1 Mbps, Auto rate 802.11n 2.4GHz : HT20 : HT420 & HT40 MCS 0-7
<b>CABLE LENGTH</b>	---	1 meter	---	
<b>POWER CONSUMPTION</b>	0.5 W	75mA @ 5V	0.5 W	
<b>SUPPLY VOLTAGE</b>	90 - 270V AC	Port powered	12 - 30V DC	12 - 30V DC

## Accessories - Communication Adapters & Cables



**AC-IOEXP-01**



**AC-IOEXP-03**



**ACH-002**



**ACH-003**



**ACH-004**

<b>DESCRIPTION</b>	Expansion adapter for MM303X PLCs	Adapter for directing RJ25 to open terminal and also for network looping	DB9 to RJ25 cable	Both Side RJ45 type connector	Both Side RJ25 Type Connector
--------------------	-----------------------------------	--	-------------------	-------------------------------	-------------------------------



**TC02-2M-7-RTDA02-RO04-24VDC**  
90(H) x 35(W) x 60(D)mm



**LC02-72-8-LC02-RO03-AO01-230V**  
72(H) x 72(W) x 71.35(D)mm



**TC08-96-8-RTDA08-RO08-230V**  
96(H) x 63(W) x 99.1(D)mm

FEATURES	<ul style="list-style-type: none"> <li>Rail mount</li> <li>RTD (PT100) input</li> <li>ON-OFF control</li> <li>PID with auto tuning</li> <li>Rampsoak</li> </ul>	<ul style="list-style-type: none"> <li>Loadcell Input (24 Bit)</li> <li>High accuracy load sensing</li> <li>Hysteresis / PIDT control</li> <li>Realtime loadcell calibration</li> <li>Selectable excitation voltage</li> <li>Retransmission</li> </ul>	<ul style="list-style-type: none"> <li>RTD Input (PT100)</li> <li>ON-OFF Control</li> <li>PID With auto tuning</li> <li>Heat cool PID</li> <li>RS485 Communication</li> </ul>
DISPLAY TYPE	4 Digit 7 segment LED	LED Display (6 Digit white + 4 Digit green)	4 Line x 16 Characters
NO. OF KEYS	3 Keys	4 Touch key (3 User configurable)	8 Touch Keys (6 User configuration)
SUPPLY VOLTAGE	18-30VDC, 4W	90 to 270 VAC (50/60Hz), 6VA	90 to 270VAC (50/60Hz), 10VA
ANALOG INPUTS	2 Channel RTD (PT100)	2 Channel load cell	8 Channel RTD (PT100)
ANALOG RESOLUTION	12 Bit	24 Bit, Defferential	12 Bit
ANALOG OUTPUT	---	1 Channel (4-20mA)	---
DIGITAL O/P	4 Relay output	3 Relay output	8 Relay output
COMMUNICATION INTERFACE	RS485 Modbus RTU-slave		

Ordering information

MiBRX Series - Rail Mount

PRODUCT CODE	DESCRIPTION	CERTIFICATION
MiBRX-2M-1-0-0-24VAC	MiBRX 2M PS - 2 Slots, 3DI	CE
MiBRX-2M-1-0-0-24VDC	MiBRX 2M PS - 2 Slots, 3DI (incl 1FI)	CE
MiBRX-4M-1-0-0-230V	MiBRX 4M PS - 4 Slots, 5DI (incl 1FI, 1AI-V), NTC	CE
MiBRX-4M-1-1-1-230V	MiBRX 4M PS - 4 Slots, 5DI (incl 1FI, 1AI-V), NTC, RTC, Master	CE
MiBRX-4M-1-0-0-24VDC	MiBRX 4M PS - 4 Slots, 5DI (incl 1FI, 1AI-V), NTC	CE
MiBRX-4M-1-1-1-24VDC	MiBRX 4M PS - 4 Slots, 5DI (incl 1FI, 1AI-V), NTC, RTC, Master	CE
MiBRX-6M-1-1-1-230V	MiBRX 6M PS - 6 Slots, 11DI, (incl 1FI, 1AI-V) + 4RO, NTC, RTC, Master, 230VAC	CE
MiBRX-6M-2-1-1-0-1-24VDC	MiBRX 6M PS - 6 Slots, 12DI, (incl 2FI, 1AI-V), with Isolation, Master, ETHERNET & RTC, 24VDC	CE

MiBRX Series - Panel Mount

PRODUCT CODE	DESCRIPTION	CERTIFICATION
MiBRX-48-0-0-230V	MiBRX 48x96 PS - 2 slots, 6DI (incl 1FI, 1AI-V), NTC	CE
MiBRX-48-0-0-24VDC	MiBRX 48x96 PS - 2 slots, 7DI (incl 1FI, 2AI-V), 1AI-I, NTC	CE
MiBRX-72-0-0-230V	MiBRX 72x72 PS - 2 slots, 4DI (incl 1FI, 1AI-V) + 3RO, NTC	CE
MiBRX-72-0-0-24VDC	MiBRX 72x72 PS - 2 slots, 4DI (incl 1FI, 1AI-V) + 4RO, 1AI-I, NTC	CE
MiBRX-72-0-1-230V	MiBRX 72x72 PS - 2 slots, 4DI (incl 1FI, 1AI-V) + 3RO, NTC, RTC	CE
MiBRX-72-0-1-24VDC	MiBRX 72x72 PS - 2 slots, 4DI (incl 1FI, 1AI-V) + 4RO, 1AI-I, NTC, RTC	CE
MiBRX-96-1-0-24VDC	MiBRX 96x96 PS - 6 slots, 6DI (incl 1FI, 1AI-V), 1AI-I, NTC, Master	CE
MiBRX-96-1-1-24VDC	MiBRX 96x96 PS - 6 slots, 6DI (incl 1FI, 1AI-V), 1AI-I, NTC, RTC, Master	CE
MiBRX-96-1-0-230V	MiBRX 96x96 PS - 6 slots, 4DI (incl 1FI, 1AI-V), NTC, Master	CE
MiBRX-96-1-1-230V	MiBRX 96x96 PS - 6 slots, 4DI (incl 1FI, 1AI-V), NTC, RTC, Master	CE

MiBRX Series - Independent Display

PRODUCT CODE	DESCRIPTION	CERTIFICATION
MiBRX-DSP-IND-96-8-0-00-B	MiBRX Independent Display 96x96 - Customized, 14 & 7 Seg, Bar Graphs, Speedometer	CE
MiBRX-DSP-IND-96-8-2-16-B	MiBRX Independent Display 96x96 - LCD (16x2)	CE
MiBRX-DSP-IND-96-8-4-16-B	MiBRX Independent Display 96x96 - LCD (16x4)	CE
MiBRX-DSP-IND-96-8-0-00-C	MiBRX Independent Display - 3.5" Graphic touch	CE

MiBRX - Adapter Plate

PRODUCT CODE	DESCRIPTION	CERTIFICATION
MiBRX-DSP-AP-2M	MiBRX 2M Adapter Plate	CE
MiBRX-DSP-AP-4M	MiBRX 4M Adapter Plate	CE
MiBRX-DSP-AP-6M	MiBRX 6M Adapter Plate	CE

Supported I/O cards

PRODUCT CODE	DESCRIPTION	CERTIFICATION
MiBRX-SC-DI04	MiBRX Slot Card - 4 Digital Inputs	CE
MiBRX-SC-DI04-ISO	MiBRX Slot Card - 4 Digital Inputs (Isolated)	CE
MiBRX-SC-DI06	MiBRX Slot Card - 6 Digital Inputs	CE
MiBRX-SC-DI06-AC	MiBRX Slot Card - 6 Digital inputs (AC)	CE
MiBRX-SC-DI06-ISO	MiBRX Slot Card - 6 Digital Inputs (Isolated)	CE
MiBRX-SC-RO03	MiBRX Slot Card - 3 Relay Outputs	CE
MiBRX-SC-RO04	MiBRX Slot Card - 4 Relay Outputs	CE
MiBRX-SC-RO04-12V	MiBRX Slot Card - 4 Relay Output (12V)	CE
MiBRX-SC-RO05	MiBRX Slot Card - 5 Relay Outputs (1.5 A)	CE
MiBRX-SC-TO04	MiBRX Slot Card - 4 Transistor Outputs	CE
MiBRX-SC-DI02-RO02	MiBRX Slot Card - 2 Digital Inputs & 2 Relay Outputs	CE
MiBRX-SC-DI02-RO03	MiBRX Slot Card - 2 Digital Inputs & 3 Relay Outputs	CE
MiBRX-SC-DI02-TO02	MiBRX Slot Card - 2 Digital Inputs & 2 Transistor Outputs	CE
MiBRX-SC-DI02-AI01-T	MiBRX Slot Card - 2 Digital Inputs & 1 Analog Input - TC/RTD	CE
MiBRX-SC-AI02-V	MiBRX Slot Card - 2 Analog Inputs - Voltage	CE
MiBRX-SC-AI02-V-ISO	MiBRX Slot Card - 2 Analog inputs - Voltage (Isolated)	CE
MiBRX-SC-AI02-I	MiBRX Slot Card - 2 Analog Inputs - Current	CE

PRODUCT CODE	DESCRIPTION	CERTIFICATION
MiBRX-SC-AI02-I-ISO	MiBRX Slot Card - 2 Analog inputs - Current (Isolated)	CE
MiBRX-SC-AI02-V-I	MiBRX Slot Card - 2 Analog Inputs - 1 Voltage & 1 Current	CE
MiBRX-SC-AI02-TC	MiBRX Slot Card - 2 Analog Inputs - Thermocouple	CE
MiBRX-SC-AI02-TC-ISO	MiBRX Slot Card - 2 Analog inputs - Thermocouple (Isolated)	CE
MiBRX-SC-AI02-RTD	MiBRX Slot Card - 2 Analog Inputs - RTD	CE
MiBRX-SC-AI02-RTD-ISO	MiBRX Slot Card - 2 Analog inputs - RTD (Isolated)	CE
MiBRX-SC-AI02-PT1000	MiBRX Slot Card - 2 Analog Inputs - PT1000	CE
MiBRX-SC-AI02-PTC	MiBRX Slot Card - 2 Analog Inputs - PTC	CE
MiBRX-SC-AI02-NTC	MiBRX Slot Card - 2 Analog Inputs - NTC	CE
MiBRX-SC-AO01-V/I	MiBRX Slot Card - 1 Analog Output	CE
MiBRX-SC-AO02-V-I-ISO	MiBRX Slot Card - 2 Analog Outputs (Isolated)	CE
MiBRX-SC-FI02	MiBRX Slot Card - 2 Fast Inputs (10KHz)	CE
MiBRX-SC-F001-TO01	MiBRX Slot Card - 1 Fast Output (10KHz) & 1 Transistor Output	CE
MiBRX-SC-LC02	MiBRX Slot Card - 2 Analog Inputs - Load Cell (24 Bit)	CE
MiBRX-SC-DL	MiBRX Slot Card - Datalogging (2MB) & RTC	CE
MiBRX-SC-WIFI	MiBRX Slot Card - WIFI	CE
MiBRX-SC-PD	MiBRX Portable Downloader	CE

## Ordering information

### Flexible IO Solution

PRODUCT CODE	DESCRIPTION	CERTIFICATION
FL-GT35-DI04-PS-230V-CE-RoHS	Flexys Graphics -Power supply card-230VAC, 4 Digital Inputs	CE
FL-GT35-DI04-PS-24V-CE-RoHS	Flexys Graphics -Power supply card-24VDC, 4 Digital Inputs	CE
FL-GT35-DSP-CE-RoHS	Flexys Graphics- 3.5" Resistive Touch Screen	CE
FL-GT35-LG-1-0-1-CE-RoHS	Flexys Graphics- Logic card- RTC, MODBUS Expansion	CE
FL-TX4-DI04-PS-230V-CE-RoHS	Flexys Panel TX4-Power Supply Card- 230VAC, 4 Digital Inputs	CE
FL-TX4-DI04-PS-24V-CE-RoHS	Flexys Panel TX4- Power Supply Card- 24VDC, 4 Digital Input	CE
FL-TX4-LG-1-0-1-V2-CE-RoHS	Flexys Panel Tx4 - Logic Card - RTC, MODBUS & Proprietary Expansion	CE
FL-RL-DI04-PS-24V-CE-RoHS	Flexys Rail- Power supply card- 24VDC, 4 Digital Inputs	CE
FL-RL-BS-6-CE-RoHS	Flexys Rail - Base Card	CE
FL-RL-LG-1-0-1-V2-CE-RoHS	Flexys Rail - Logic Card - RTC, MODBUS & Proprietary Expansion	CE
FL-RL-PS-230V	Flexys Rail - Power Supply Card- 230VAC	---

### Compact Series

PRODUCT CODE	DESCRIPTION	CERTIFICATION
DIGIX-1-0-0-24VDC-B	PLC-8DI, 5RO& 230VAC- RTC & MODBUS Expansion	CE in process
DIGIX-1-230V	PLC- 8DI, 5RO & 230VAC	CE
DIGIX-1-0-0-24VDC	PLC- 8DI, 5RO & 24VDC	CE in process
DIGIX-1-1-1-230V	PLC- 8DI, 5RO & 230AC- RTC & MODBUS Expansion	CE
DIGIX-2-1-0-24VDC	PLC- 10DI, 8RO, 2AI-V/2DI & 24VDC- MODBUS Expansion	CE
DIGIX-4-1-1-24VDC	PLC- 10DI, 6TO & 24VDC- RTC & MODBUS Expansion	CE
UNIX-1-230V	PLC-3DI, 2RO, 2TO, 3AI (1TC/RTD, 1I, 1V/1DI) & 230VAC	CE in process
TWIX-1-230V	PLC- 6DI, 4RO, 1AI (TC/RTD) & 230VAC	CE in process
TWIX-1-24VDC	PLC- 6DI, 4RO, 1AI (TC/RTD) & 24VDC	CE in process
TWIX-2-230V	PLC- 6DI, 5RO, 6AI (2TC/RTD, 2I, 2V/2DI), 1AO(V/I) & 230VAC	CE in process
TWIX-2-24V	PLC- 6DI, 5RO, 6AI (2TC/RTD, 2I, 2V/2DI), 1AO(V/I) & 24VDC	CE in process
TWIX-3-24VDC	PLC- 8DI, 6DO, 1AI (TC/RTD) & 24VDC	CE in process

### Supported I/O cards

PRODUCT CODE	DESCRIPTION	CERTIFICATION
EXP-FLEX 2M	Expansion slot - Flexys IO cards	CE
EXP-FLEX 2M V3	Expansion slot - Flexys IO cards	CE in process
FL-SC-DI10-CE-RoHS	10 Digital inputs card	CE
FL-SC-DI14-CE-RoHS	14 Digital inputs card	CE
FL-SC-RO08-CE-RoHS	8 Channel relay output card	CE
FL-SC-TO08-CE-RoHS	8 Channel transistor output card	CE
FL-SC-DI04-RO04-CE-RoHS	4 Digital input, 4 Relay output card	CE
FL-SC-AI04-U	4 Channel analog input card - Universal	CE in process
FL-SC-AI04-RTD-CE-RoHS	4 Channel analog input card - RTD (PT-100)	CE
FL-SC-AI04-TC-CE-RoHS	4 Channel analog input card - Thermocouple	CE
FL-SC-AIDF04-TC-CE-RoHS	4 Channel differential analog input card - Thermocouple	CE
FL-SC-AI06-V-CE-RoHS	6 Channel analog input card - Voltage	CE
FL-SC-AI06-I-CE-RoHS	6 Channel analog input card - Current	CE
FL-SC-AI03-NTC-AI03-I	3 Channel analog input – NTC, 3 channel analog input – Current card	CE in process
FL-SC-AO04-V-CE-RoHS	4 Channel analog output card - Voltage	CE
FL-SC-AO04-I-CE-RoHS	4 Channel analog output card - Current	CE
FL-SC-AI03-U-AO02-U	3 Channel analog input - Universal, 2 Channel analog output - Universal card	CE in process
FL-SC-LC04	4 Channel loadcell input card	CE in process

### Fixed IO Configuration

PRODUCT CODE	DESCRIPTION	CERTIFICATION
MM3030-4	PLC- 10DI, 8RO, 2AI (V/I), 24VDC	CE in process
MM3032-2-0-0-230V V2	PLC- 8DI, 6RO, 2AI (V/I), 1AO (0-10V DC), 230VAC	CE in process
MM3032-2-0-0-24V V2	PLC- 8DI, 6RO, 1AI (V/I), 1AI-NTC & 24VDC	CE in process

### Standard Function Products

PRODUCT CODE	DESCRIPTION	CERTIFICATION
TC02-2M-7-RTDA02-RO04-24VDC	2 Channel Temperature Controller	CE
LC02-72-8-LC02-RO03-A001-230V	2 Channel Loadcell Controller With Retransmission	CE
TC08-96-8-RTDA08-RO08-230V	2 Channel Temperature Scanner Cum Controller	CE

### Relay Module

PRODUCT CODE	PRODUCT CODE	CERTIFICATION
RLYMD-1-S4-1CO-24VDC-CE-RoHS	4 Channel 1 Change Over	CE
RLYMD-1-S4-2CO-24VDC-CE-RoHS	4 Channel 2 Change Over	CE
RLYMD-2-S8-1CO-24VDC-CE-RoHS	8 Channel 1 Change Over	CE
RLYMD-2-S8-2CO-24VDC-CE-RoHS	8 Channel 2 Change Over	CE
ERLYMD-2-1-S8-1CO-24V-CE-RoHS	8 Channel 1 Change Over, Communication Based	CE

### Data Converters / Accessories

PRODUCT CODE	CERTIFICATION	PRODUCT CODE	CERTIFICATION
AC-USB-RS232-01	CE in process	ACH-001	CE
AC-USB-RS485-02	CE	ACH-002	CE
AC-USB-RS485-03	CE	ACH-003	CE
AC-S2E-02	CE	ACH-004	CE
AC-IOEXP-01	CE	AC-RS485-RS232-ISO	CE in process
AC-IOEXP-03	CE		



**SP112-GT40**  
102(H) x 138(W) x 32(D)mm



**SP112-GT70**  
146(H) x 200(W) x 32(D)mm



**SP112-GT100**  
193(H) x 273(W) x 32(D)mm

## FEATURES

- 4.3", 7" & 10" Touch screen
- Ethernet / Serial communication
- User management
- Recipe management
- Data logging
- Update program by USB flash
- In-Built third party PLC protocols
- Thermal printer support
- In-Built buzzer for alarm condition

DISPLAY	4.3" Diagonal resistive touch screen	7" Diagonal resistive touch screen	10" Diagonal resistive touch screen
RESOLUTION	480 x 272 pixels	800 x 480 pixels	1024 x 600 pixels
USER MEMORY	256M Flash + 256M DRAM		256M Flash + 128M DRAM
DATA LOGGING	Yes		
COMM. PORT 1	RS485/ RS422 MODBUS RTU protocol		RS485 MODBUS RTU protocol
COMM. PORT 2	RS232 MODBUS RTU protocol, Multiple communication protocols		
COMM. PORT 3	---	RS485 MODBUS RTU protocol	---
ETHERNET	Ethernet - 10M/ 100M Self adaptation		
USB HOST	USB2.0x1, Support USB flash disk to update firmware, Configure and store data		
USB SLAVE	Type C, Support power supply & program download/ upload	Type B, program download / upload	
KEYS	---		
RTC	Yes		
BACKUP BATTERY	3 V CR2032		
OPERATING TEMPERATURE	0° - 50° C		
SUPPLY VOLTAGE	24 V DC (20.4~28.8 V DC)		

# Power Supply - Din Rail Series



**RP-2M-1.1A-24VDC-CE-RoHS**  
90(H) X 35(W) x 60(D)mm



**RPS15**  
90(H) X 17.50(W) x 65(D)mm



**RPS40**  
90(H) X 35(W) x 60(D)mm

## FEATURES

- IEC 61010-1 safety standards
- Protection: Overload, Over voltage, Short circuit
- Power OK indication
- Cooling by free air convection
- Ultra slim
- Support wide range of AC/DC auxiliary supply
- Efficiencies up to 82%
- Full power between -25°C to +50°C
- Protection against Short circuit, Overload, Over voltage
- Cooling by free air convection

DISPLAY	LED indication for DC OK		
VOLTAGE RANGE	100 - 270 VAC/ 100-300 VDC	90-264 VAC/ 127-370 VDC	
FREQUENCY RANGE	50/ 60 Hz		
AC CURRENT	100 V-0.6 A, 270 V-0.3 A	0.3 A @115 VAC; 0.15 A@230 VAC	0.80 A@115 VAC; 0.5 A@230 VAC
EFFICIENCY	Up to 75% to 85%	82%	85%
INRUSH CURRENT	< 40 Amps@115 VAC < 75 Amps@230 VAC	< 30 Amps@264 VAC	
AVAILABLE RANGE DC VOLTAGE / CURRENT	24 V/ 1.1A	05 V/ 2.4 A, 12 V/ 1.25 A, 24 V/ 0.63 A	12 V/ 2.5 A, 15 V/ 2.67 A, 24 V/ 1.67 A, 48 V/ 0.83 A
RATED POWER	26.4 W	15 W	40 W
RIPPLE & NOISE MAX (mVp.p)	200 mV	< 1 % of Vout	
WEIGHT	140 g	< 100 g	< 150 g

## Power Supply - Din Rail Series



**RPS60**  
109.8(H) X 43(W) x 102.7(D)mm



**RPS120**  
109.8(H) X 43(W) x 102.7(D)mm



**RPS240**  
136(H) X 50(W) x 135(D)mm



**RPS480**  
154(H) X 60(W) x 158(D)mm

FEATURES	<ul style="list-style-type: none"> <li>Designed to meet UL 62368-1</li> <li>IEC 61010-1 safety standard</li> <li>Protection: Overload, Over voltage, Output Short Circuit, Over Temperature</li> <li>Power OK Indication</li> <li>Cooling by free air convection</li> </ul>		<ul style="list-style-type: none"> <li>Designed to meet UL 62368-1</li> <li>Active PFC</li> <li>Protection: Overload, Over voltage, Output Short Circuit, Over Temperature</li> <li>Power OK indication</li> <li>DC OK relay contact</li> <li>Cooling by free air convection</li> </ul>	
	LED indication for DC OK			
DISPLAY	LED indication for DC OK			
VOLTAGE RANGE	90 - 264 VAC/ 127 - 370 VDC			
FREQUENCY RANGE	50/ 60 Hz			
AC CURRENT	115 V - 1.2 A, 230 V - 0.8 A	115 V - 2.2 A, 230 V - 1.5 A	115 V - 2.4 A, 230 V - 1.2 A	115 V - 4.8 A, 230 V - 2.4 A
EFFICIENCY	Up to 87 %	Up to 89 %	Up to 93 %	Up to 94 %
INRUSH CURRENT	< 48 A@264 VAC		< 60 A@264 VAC	
AVAILABLE RANGE DC VOLTAGE / CURRENT	05 V/ 10 A, 12 V/ 5 A, 15 V/ 4 A, 24 V/ 2.5 A, 48 V/ 1.25 A	12 V/ 8 A, 15 V/ 8 A, 24 V/ 5 A, 48 V/ 2.5 A	12 V/ 18 A, 24 V/ 10 A, 48 V/ 5 A	24 V/ 20 A, 48 V/ 10 A
RATED POWER	60 W	120 W	240 W	480 W
RIPPLE & NOISE MAX (mVp.p)	< 1% of Vout			
WEIGHT	285 g	350 g	645 g	1050 g

## Power Supply - Open Frame Series



**OPS2x3-40**  
76.2(L) X 50.8(W) x 30(H)mm

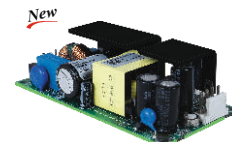

**OPS2x4-60**  
101.6(L) X 50.8(W) x 30(H)mm

FEATURES	<ul style="list-style-type: none"> <li>3 x 2 x 1.16 Inches Form factor</li> <li>40 Watts convection</li> </ul>		<ul style="list-style-type: none"> <li>4 x 2 x 1.16 Inches Form factor</li> <li>60 Watts Convection</li> </ul>	
	<ul style="list-style-type: none"> <li>No Load power &lt; 0.5 W</li> <li>- 40°C to + 70°C Operating temperature</li> <li>Designed to meet IEC/ UL 62368-1 and IEC/ EN 60601-1</li> <li>Class II option available</li> <li>Medical (BF) safety approvals</li> <li>Approved to household, ITAV &amp; medical standards</li> </ul>			
Voltage range	90 - 264 VAC (127 - 370 VDC)			
Available Range (Convection) DC Voltage / Current	5 V/ 5 A, 12 V/ 3.33 A, 15 V/ 2.67 A, 24 V/ 1.67 A, 48 V/ 0.83 A		5 V/ 10 A, 12 V/ 5 A, 15 V/ 4 A, 24 V/ 2.5 A, 48 V/ 1.25 A	
FREQUENCY RANGE	50/ 60 Hz			
AC CURRENT	0.85 A@115 VAC; 0.45 A@230 VAC		1.2 A@115 VAC; 0.8 A@230 VAC	
EFFICIENCY @230V	Up to 86 %		Up to 87 %	
INRUSH CURRENT	< 60 Amps; Measured at 264 VAC, 25°C Ambient, Cold start			
RATED POWER	40 W		60 W	
RIPPLE & NOISE (max)	< 1 % of Vout			
DIMENSION	Overall: 3" x 2" x 1.16" (L x W x H); Height above PCB : 1"		Overall: 4" x 2" x 1.16" (L x W x H); Height above PCB : 1"	
WEIGHT	< 100 g		< 150 g	

## Power Supply - Open Frame Series

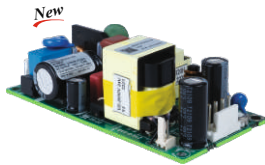

**OPS2x4-150**  
101.6(L) X 50.8(W) x 30(H)mm

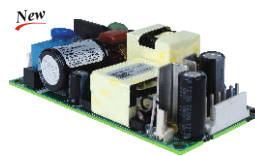

**OPS2x4-200**  
101.6(L) X 50.8(W) x 30(H)mm



**OPS3x5-350**  
127(L) X 76.2(W) x 30(H)mm

FEATURES	<ul style="list-style-type: none"> <li>• 4 x 2 x 1.16 Inches Form factor</li> <li>• 150 Watts with Forced Air Cooling &amp; 100 Watts Convection cooling</li> </ul>	<ul style="list-style-type: none"> <li>• 4 x 2 x 1.16 Inches Form factor</li> <li>• 200 Watts with Forced Air Cooling &amp; 130 Watts Convection Cooling</li> </ul>	<ul style="list-style-type: none"> <li>• 5 x 3 x 1.16 Inches Form factor</li> <li>• 350 Watts with Forced Air Cooling &amp; 200 Watts Convection Cooling</li> <li>• Remote Inhibit available</li> </ul>
	<ul style="list-style-type: none"> <li>• 12 V / 0.5 A Fan Output, Thermal Shut-Down feature</li> <li>• No Load power &lt; 0.5 W</li> <li>• - 40°C to + 70°C Operating temperature</li> <li>• Designed to meet IEC/ UL 62368-1 and IEC/ EN 60601-1</li> <li>• Class II option available</li> <li>• Medical (BF) safety approvals</li> <li>• Approved to household, ITAV &amp; medical standards</li> </ul>		
Voltage range	90 - 264 VAC (127 - 370 VDC)		
Available Range (Convection) DC Voltage / Current	12 V/ 8.33 A, 15 V/ 6.67 A, 24 V/ 4.17 A, 48 V/ 2.1 A	12 V/ 10.84 A, 15 V/ 8.67A, 24 V/ 5.42 A, 48 V/ 2.71 A	12 V/ 16.67 A, 15 V/ 13.33 A, 24 V/ 8.33 A, 48 V/ 4.17 A
Available Range (Forced Air) DC Voltage / Current	12 V/ 12.5 A, 15 V/ 10 A, 24 V/ 6.25 A, 48 V/ 3.13 A	12 V/ 16.67 A, 15 V/ 13.34 A, 24 V/ 8.34 A, 48 V/ 4.17 A	12 V/ 25.00 A, 15 V/ 23.34 A, 24 V/ 14.59 A, 48 V/ 7.30 A
FREQUENCY RANGE	50/ 60 Hz		
AC CURRENT	1.5 A@115 VAC; 0.74 A@230 VAC	2.0 A @ 115 VAC; 1.1 A @ 230 VAC	3.6 A@115 VAC; 1.8 A@230 VAC
EFFICIENCY@230 V	Up to 90 %		Up to 93 %
INRUSH CURRENT	< 60 Amps; Measured at 264 VAC, 25°C Ambient, Cold start		
RATED POWER	150 W	200 W	350 W
RIPPLE & NOISE (max)	< 1% of Vout		
DIMENSION	Overall: 4" x 2" x 1.16" (L x W x H); Height above PCB : 1"	Overall: 4" x 2" x 1.16" (L x W x H); Height above PCB : 1"	Overall: 5" x 3" x 1.16" (L x W x H); Height above PCB : 1"
WEIGHT	< 200 g	< 180 g	< 300 g

## Power Supply - Din Rail



**LRPS240**  
154(H) X 60(W) x 158(D)mm



**BC1-1210**  
190(H) X 60(W) x 140.75(D)mm



**BC2-2410**  
190(H) X 80(W) x 140.75(D)mm

FEATURES	<ul style="list-style-type: none"> <li>• Low cost CVCC power supply</li> <li>• Cooling by built in fan</li> <li>• Designed to meet UI508 &amp; IEC 62358-1</li> </ul>	<ul style="list-style-type: none"> <li>• CVCC Charging profile</li> <li>• Charging indication with LED</li> <li>• Prevents over charging of battery</li> <li>• Full power between 0°C &amp; + 50°C</li> <li>• Wide-range input 150 - 270 VAC</li> </ul>
	LED induction for DC OK	
DISPLAY	LED indication for battery charging	
VOLTAGE RANGE	170 - 264 VAC	150 - 270 VAC
FREQUENCY RANGE	50/ 60 Hz	
AC CURRENT	2.8 A@150 VAC; 2.1 A@ 230 VAC	150 V - 2.4 A, 230 V - 1.7 A
EFFICIENCY	Up to 87 %	Up to 80 %@230 VAC
INRUSH CURRENT	< 60 Amps; Measured at 264 VAC	< 70 A@270 VAC
DC VOLTAGE	24 V/ 10 A, 48 V/ 5 A	12 VDC
RATED CURRENT		10 A
RATED POWER	240 W	120 W
RIPPLE & NOISE MAX (mVp.p)	< 1 % of Vout	
WEIGHT	680 g	1050 g
		1280 g



## Ordering information

### Human Machine Interface

PRODUCT CODE	DESCRIPTION	CERTIFICATION
SP112-GT40-S-CE	4.3" Touch screen HMI with Serial ports	CE in process
SP112-GT40-ET-CE	4.3" Touch screen HMI with Ethernet & Serial ports	CE in process
SP112-GT70-S1-CE	7" Touch screen HMI with Serial ports	CE
SP112-GT70-ET1-CE	7" Touch screen HMI with Ethernet & Serial ports	CE
SP112-GT100-ET-CE	10" Touch screen HMI with Ethernet & Serial ports	CE

### DIN Rail Power Supply

PRODUCT CODE	CERTIFICATION	Eg.: RPS15-24-CE RPS15 - XX - YY
RPS15-05-CE	CE	
RPS15-12-CE	CE	
RPS15-24-CE	CE	

PRODUCT CODE	CERTIFICATION	Eg.: RPS40-24-CE RPS40 - XX - YY
RPS40-12-CE	CE	
RPS40-15-CE	CE	
RPS40-24-CE	CE	
RPS40-48-CE	CE	

PRODUCT CODE	CERTIFICATION
RPS60-05	---
RPS60-12	---
RPS60-15	---
RPS60-24	---
RPS60-48	---
RPS60-05-CU	CE
RPS60-12-CU	CE
RPS60-15-CU	CE
RPS60-24-CU	CE
RPS60-48-CU	CE

PRODUCT CODE	CERTIFICATION
Eg.: RPS60-24 RPS60 - XX - YY	, from YY to Output Voltage: 05: 5V, 12: 12V, 15: 15V, 24: 24V, 48: 48V, and from the whole code to Output Power: 60W."/>

PRODUCT CODE	CERTIFICATION
RPS120-12	---
RPS120-15	---
RPS120-24	---
RPS120-48	---
RPS120-12-CU	CE
RPS120-15-CU	CE
RPS120-24-CU	CE
RPS120-48-CU	CE

PRODUCT CODE	CERTIFICATION
Eg.: RPS120-24-CU RPS120 - XX - YY	, from YY to Output Voltage: 12: 12V, 15: 15V, 24: 24V, 48: 48V, and from the whole code to Output Power: 120W."/>

### DIN Rail Power Supply

PRODUCT CODE	CERTIFICATION
RPS240-12-CU	CE
RPS240-24-CU	CE
RPS240-48-CU	CE

PRODUCT CODE	CERTIFICATION
Eg.: RPS240-24-CU RPS240 - XX - YY	, from YY to Output Voltage: 12: 12V, 24: 24V, 48: 48V, and from the whole code to Output Power: 240W."/>

PRODUCT CODE	CERTIFICATION
RPS480-24-CU	CE
RPS480-48-CU	CE

PRODUCT CODE	CERTIFICATION
Eg.: RPS480-24-CU RPS480 - XX - YY	, from YY to Output Voltage: 24: 24V, 48: 48V, and from the whole code to Output Power: 480W."/>

PRODUCT CODE	CERTIFICATION
LRPS240-24	---
LRPS240-48	---

### Open Frame Power Supply

PRODUCT CODE	CERTIFICATION
OPS2x3-40-05-A-1-CU	
OPS2x3-40-12-A-1-CU	
OPS2x3-40-15-A-1-CU	
OPS2x3-40-24-A-1-CU	
OPS2x3-40-48-A-1-CU	
OPS2x4-60-05-A-1-CU	
OPS2x4-60-12-A-1-CU	
OPS2x4-60-15-A-1-CU	
OPS2x4-60-24-A-1-CU	
OPS2x4-60-48-A-1-CU	
OPS2x4-150-12-A-1-CU	
OPS2x4-150-15-A-1-CU	
OPS2x4-150-24-A-1-CU	
OPS2x4-150-48-A-1-CU	
OPS2x4-200-12-A-1-CU	
OPS2x4-200-15-A-1-CU	
OPS2x4-200-24-A-1-CU	
OPS2x4-200-48-A-1-CU	
OPS3x5-350-12-A-1-CU	
OPS3x5-350-15-A-1-CU	
OPS3x5-350-24-A-1-CU	
OPS3x5-350-48-A-1-CU	

### Battery Chargers

PRODUCT CODE	CERTIFICATION
BC1-1210	---
BC2-2410	---



VFD-L



VFD-S

FEATURES	<ul style="list-style-type: none"> <li>• Compact VFD</li> <li>• 0.5HP 0.4kW &amp; 1HP 0.75kW</li> </ul>	<ul style="list-style-type: none"> <li>• Standard General Purpose VFD</li> <li>• 0.5HP 0.4kW to 20HP 15kW</li> </ul>
RATED INPUT VOLTAGE / FREQUENCY	Single Phase 230 VAC 50Hz / 60 Hz	Single Phase 230 VAC 50Hz / 60 Hz, Three Phase 415 VAC 50Hz / 60Hz
PERMISSIBLE VOLTAGE FLUCTUATION	230 VAC ±15%	230 VAC ±15% for 1 phase & 415 VAC ±15% for 3 phase
PERMISSIBLE FREQUENCY FLUCTUATION	±5%	
CONTROL MODE	V/F control	
FREQUENCY CONTROL RANGE	0.1 ~ 400.0 Hz	
FREQUENCY ACCURACY	Digital setting 0.01%, Analog instruction 0.1% (Max frequency)	
FREQUENCY RESOLUTION	Digital instruction 0.1Hz, Analog instruction 0.1 Hz	
ACCELERATION/DECELERATION TIME	0.0 ~ 999.9 Sec. Four acceleration / deceleration time settings available	0.0 ~ 3600.0 Sec. Four acceleration / deceleration time settings available
MULTI SPEED RUNNING	Built-in program using Simple PLC feature	
BUILT-IN PI	Easy to set up a simple automatic control system	
BUILT-IN COUNTER	Automatically controlled production line can be achieved	
OVERLOAD CAPACITY	150% for 1min, 180% for 10s, 200% for 1s	
V/F MODE	4 pre-set V/F mode and 1 User Defined V/F program	
AUTOMATIC ENERGY SAVING OPERATION	Changes the V/F curve according to the load to reduce energy consumption	
AUTOMATIC VOLTAGE REGULATION	Regulates the voltage automatically whenever there is a change in grid voltage	
OPERATION COMMANDS	Keypad, External terminals, External communication using MODBUS	
FREQUENCY SETTING	Keypad Up/Down keys, Keypad potentiometer, External potentiometer, Analog inputs (4-20mA/0-10V), MODBUS communication	
INPUT SIGNAL	4 User Selectable (PNP/NPN) Multifunction Inputs 2 analog inputs (0-20mA, POT / 0-10V)	8 User Selectable (PNP/NPN) Multifunction Inputs 2 analog inputs (0-10V / 0-20mA)
OUTPUT SIGNAL	1 User Selectable Multifunction Relay Output (250V/5A Contact)	2 User Selectable Multifunction Relay Output (250V/5A Contact), 2 User Selectable Multifunction Open Collector Output, 1 Analog Output (0-10V/0-20mA)
PROTECTION FUNCTIONS	Over Current, Over Voltage, Under Voltage, Over Temperature, Under Current, System Error	
DISPLAY	Non-removable HMI with 5 keys, 4x7 segment LED display and 4 status LED setting, Running status and fault display	Removable HMI with 8 keys, 1 switch enabled encoder, 5x7 segment LED display and 7 status LEDs
OPERATING ENVIRONMENT	Temperature : -10 ~ +55°C, Humidity : < 90%, No condensation, IP20	
STORAGE TEMPERATURE	-20 ~ +60°C	
VIBRATION	<5.9 m/s <sup>2</sup> (0.6g)	
APPLICATIONS	Suitable for Fans, Pumps, Conveyor, Food & drink packaging machinery, Industrial washing machine and most general industries etc.	

## Ordering information

### Variable Frequency Drive (VFD-L)

PRODUCT CODE	DESCRIPTION	CERTIFICATION
VFD-L-1-005-230V	1 phase input 230VAC, 3 phase output 0 to rated Input voltage, 0.5HP/0.4kW Economic Series (4DI, 2AI, 2AO, RS485, 1RO SPST, Built in display)	---
VFD-L-1-010-230V	1 phase input 230VAC, 3 phase output 0 to rated Input voltage, 1HP/0.75kW Economic Series (4DI, 2AI, RS485, 1RO SPST, Built in display)	---

### Variable Frequency Drive (VFD-S)

PRODUCT CODE	DESCRIPTION	CERTIFICATION
VFD-S-1-005-230V	1 phase input 230VAC, 3 phase output 0 to rated Input voltage 0.5HP / 0.4kW, General Purpose series (5DI, 2AI, 1AO, RS485, 1RO SPDT, 1TO, Detachable display)	---
VFD-S-1-010-230V	1 phase input 230VAC, 3 phase output 0 to rated Input voltage 1HP/0.75kW, General Purpose series (5DI, 2AI, 1AO, RS485, 1RO SPDT, 1TO, Detachable display)	---
VFD-S-1-020-230V	1 phase input 230VAC, 3 phase output 0 to rated Input voltage 2HP/1.5kW, General Purpose series (5DI, 2AI, 1AO, RS485, 1RO SPDT, 1TO, Detachable display)	---
VFD-S-3-010-415V	3 phase input 415VAC, 3 phase output 0 to rated Input voltage 1HP/0.75kW, General Purpose series (5DI, 2AI, 1AO, RS485, 1RO SPDT, 1TO, Detachable display)	---
VFD-S-3-020-415V	3 phase input 415VAC, 3 phase output 0 to rated Input voltage 2HP/1.5kW, General Purpose series (5DI, 2AI, 1AO, RS485, 1RO SPDT, 1TO, Detachable display)	---
VFD-S-3-030-415V	3 phase input 415VAC, 3 phase output 0 to rated Input voltage 3HP/2.2kW, General Purpose series (5DI, 2AI, 1AO, RS485, 1RO SPDT, 1TO, Detachable display)	---

### Variable Frequency Drive (VFD-S)

PRODUCT CODE	DESCRIPTION	CERTIFICATION
VFD-SH-3-050-B-415V	3 PH 415VAC IN, 3 PH 0-415VAC OUT 5HP/3.7kW, Heavy Duty General Purpose series (8 DIs, 2 AI, RS485, 2 RO, 2 TO, 1AO, Detachable Display)	---
VFD-SN-3-075-B-415V	3 PH 415VAC IN, 3 PH 0-415VAC OUT 7.5HP/5.5kW, Normal duty General Purpose series (8 DIs, 2 AI, RS485, 2 RO, 2 TO, 1AO, Detachable Display)	---
VFD-SH-3-075-B-415V	3 PH 415VAC IN, 3 PH 0-415VAC OUT 7.5HP/5.5kW, Heavy duty General Purpose series (8 DIs, 2 AI, RS485, 2 RO, 2 TO, 1AO, Detachable Display)	---
VFD-SN-3-100-B-415V	3 PH 415VAC IN, 3 PH 0-415VAC OUT 10HP/7.5kW, Normal Duty General Purpose series (8 DIs, 2 AI, RS485, 2 RO, 2 TO, 1AO, Detachable Display)	---
VFD-SH-3-100-B-415V	3 PH 415VAC IN, 3 PH 0-415VAC OUT 10HP/7.5kW, Heavy Duty General Purpose series (8 DIs, 2 AI, RS485, 2 RO, 2 TO, 1AO, Detachable Display)	---
VFD-SH-3-150-B-415V	3 PH 415VAC IN, 3 PH 0-415VAC OUT, 15HP/11kW, Heavy Duty General Purpose series (8 DIs, 2 AI, RS485, 2 RO, 2 TO, 1AO, Detachable Display)	---
VFD-SN-3-200-B-415V	3 PH 415VAC IN, 3 PH 0-415VAC OUT, 20HP/15kW, Normal duty General Purpose series (8 DIs, 2 AI, RS485, 2 RO, 2 TO, 1AO, Detachable Display)	---
VFD-SH-3-200-B-415V	3 PH 415VAC IN, 3 PH 0-415VAC OUT, 20HP/15kW, Heavy duty General Purpose series (8 DIs, 2 AI, RS485, 2 RO, 2 TO, 1AO, Detachable Display)	---



**FD100**



**FD300**

FEATURES	<ul style="list-style-type: none"> <li>Compact &amp; powerful AC drives</li> <li>1HP 0.75kW to 5HP 3.7kW</li> </ul>	<ul style="list-style-type: none"> <li>High performance AC drives</li> <li>5HP 3.75kW to 200HP 160kW</li> </ul>
RATED INPUT VOLTAGE / FREQUENCY	Single Phase 230 VAC 50Hz / 60Hz, Three Phase 415 VAC 50Hz / 60Hz	
PERMISSIBLE VOLTAGE FLUCTUATION	187V to 253 VAC for 1 phase & 320 to 460 VAC for 3 Phase	
PERMISSIBLE FREQUENCY FLUCTUATION	±5%	
CONTROL MODE	V/F control	SFVC, CLVC (+PG Card), V/F Control
FREQUENCY CONTROL RANGE	0.1 ~ 400.0 Hz	Vector control : 0.0 ~ 3200.0Hz, V/F control : 0.0 ~ 500.0Hz
FREQUENCY ACCURACY	Digital setting 0.01%, Analog instruction 0.1% (Max frequency)	
FREQUENCY RESOLUTION	Digital instruction 0.1Hz, Analog instruction 0.1 Hz	
ACCELERATED / DECELERATED TIME	0.0 ~ 3600.0 Sec. Four acceleration / deceleration time settings available	0.0 ~ 6500.0 Sec. Four acceleration / deceleration time settings available
MULTI SPEED RUNNING	Built-in program	
BUILT-IN PI	Easy to set up a simple automatic control system	
OVERLOAD CAPACITY	G Type - 150% rated current for 1 min, P type - 120% rated current for 1 min	
TORQUE BOOST	Manual Boost : 0 - 15%	Auto Boost , Manual Boost : 0 - 30%
V/F MODE	3 preset V/F mode and V/F program	
AUTOMATIC ENERGY SAVING OPERATION	Changes the V/F curve according to the load to save energy	
AUTOMATIC VOLTAGE REGULATION	Regulates the voltage automatically whenever there is a change in grid voltage	
OPERATION COMMANDS	Keypad, External terminals and Communication	
FREQUENCY SETTING	Digital setting, Analog voltage setting, Analog current setting, Communication	
INPUT SIGNAL	Forward / Reverse, Jogging selection, Multi speed control, Regular stopping	
OUTPUT SIGNAL	Fault alarm output (250V/2A Contact), Open collector output	
PROTECTION FUNCTIONS	Over current, Over voltage, Under voltage, Over heat, Overload, Phase loss	
DISPLAY	Parameters setting, Running status and fault display	
OPERATING ENVIRONMENT	Temperature : -10 ~ +50°C, Humidity : < 90%, No condensation, IP20	
OPERATIONS AREA	Indoor, <1000m altitude above sea level	
STORAGE TEMPERATURE	-20 ~ +60°C	
VIBRATION	<5.9 m/s <sup>2</sup> (0.6g)	
INPUT CHANNEL	5 DIs (Internal impedance : 3.3kΩ), 2AIs (0-10V, 0-10V/0-20mA)	6 DIs (Internal impedance : 3.3kΩ), 2AIs (0-10V, 0-10V/0-20mA)
OUTPUT CHANNEL	1 RO, 1 TO, 1AO (0-10V/0-20mA)	1 RO, 2 TO, 1AO (0-10V/0-20mA)
APPLICATIONS	Suitable for Fans, Pumps, Conveyor, Food & drink packaging machinery, Industrial washing machine and most general industries etc.	Suitable for Fans, Pumps, Conveyor, Mixer, Textile machine, Dyeing machine, Lithographic printing machine Metal working

### Ordering information

#### Variable Frequency Drive (FD100)

PRODUCT CODE	DESCRIPTION	CERTIFICATION
FD100-1-010-C-CE	1 PH 230VAC IN, 3 PH 0-230VAC OUT 1HP/0.75kW	CE
FD100-1-020-C-CE	1 PH 230VAC IN, 3 PH 0-230VAC OUT 2HP/1.5kW	CE
FD100-1-030-C-CE	1 PH 230VAC IN, 3 PH 0-230VAC OUT 3HP/2.2kW	CE
FD100-3-010-C-CE	3 PH 415VAC IN, 3 PH 0-415VAC OUT 1HP/0.75kW	CE
FD100-3-020-C-CE	3 PH 415VAC IN, 3 PH 0-415VAC OUT 2HP/1.5kW	CE
FD100-3-030-C-CE	3 PH 415VAC IN, 3 PH 0-415VAC OUT 3HP/2.2kW	CE
FD100-3-050-C-CE	3 PH 415VAC IN, 3 PH 0-415VAC OUT 5HP/3.75kW	CE

#### Variable Frequency Drive (FD300)

PRODUCT CODE	DESCRIPTION	CERTIFICATION
FD300-3-050-C-CE	3 PH 415VAC IN, 3 PH 0-415VAC OUT 5HP/3.75kW	CE
FD300-3-075-C-CE	3 PH 415VAC IN, 3 PH 0-415VAC OUT 7.5HP/5.5kW	CE
FD300-3-100-C-CE	3 PH 415VAC IN, 3 PH 0-415VAC OUT 10HP/7.5kW	CE
FD300-3-150-C-CE	3 PH 415VAC IN, 3 PH 0-415VAC OUT 15HP/11kW	CE
FD300-3-200-C-CE	3 PH 415VAC IN, 3 PH 0-415VAC OUT 20HP/15kW	CE
FD300-3-250-C-CE	3 PH 415VAC IN, 3 PH 0-415VAC OUT 25HP/18.5kW	CE
FD300-3-300-C-CE	3 PH 415VAC IN, 3 PH 0-415VAC OUT 30HP/22.4kW	CE
FD300-3-400-C-CE	3 PH 415VAC IN, 3 PH 0-415VAC OUT 40HP/30kW	CE
FD300-3-500-C-CE	3 PH 415VAC IN, 3 PH 0-415VAC OUT 50HP/37.5kW	CE
FD300-3-600-C-CE	3 PH 415VAC IN, 3 PH 0-415VAC OUT 60HP/45kW	CE
FD300-3-750-C-CE	3 PH 415VAC IN, 3 PH 0-415VAC OUT 75HP/55kW	CE
FD300-3-1000-C-CE	3 PH 415VAC IN, 3 PH 0-415VAC OUT 100HP/75kW	CE
FD300-3-1200-C-CE	3 PH 415VAC IN, 3 PH 0-415VAC OUT 120HP/90kW	CE
FD300-3-1500-C-CE	3 PH 415VAC IN, 3 PH 0-415VAC OUT 150HP/110kW	CE
FD300-3-1750-C-CE	3 PH 415VAC IN, 3 PH 0-415VAC OUT 175HP/132kW	CE
FD300-3-2100-C-CE	3 PH 415VAC IN, 3 PH 0-415VAC OUT 210HP/160kW	CE



FD9

FEATURES	<ul style="list-style-type: none"> <li>• High Performance AC drives</li> <li>• 1HP 0.75kW to 210HP 160kW</li> </ul>
RATED INPUT VOLTAGE / FREQUENCY	Single Phase 230 VAC 50Hz / 60Hz, Three Phase 415 VAC 50Hz / 60Hz
PERMISSIBLE VOLTAGE FLUCTUATION	-20 % ~ +15 %
PERMISSIBLE FREQUENCY FLUCTUATION	±5%
CONTROL MODE	V/F, Sensorless vector control (SVC), Speed Sensor vector control (FVC)
FREQUENCY CONTROL RANGE	0.0 ~ 5000.0 Hz
FREQUENCY ACCURACY	Digital setting 0.01%, Analog instruction 0.1% (Max frequency)
FREQUENCY RESOLUTION	Digital instruction 0.1Hz, Analog instruction 0.1 Hz
ACCELERATED / DECELERATED TIME	0.0 ~ 6000.0 Sec. Four accelerate / decelerate time settings available
MULTI SPEED RUNNING	Built-in program
BUILT-IN PI	Easy to set up a simple automatic control system
OVERLOAD CAPACITY	150% rated current for 1minute, 180% rated current for 3 seconds
TORQUE BOOST	0-30%(Manual & Auto boost)
V/F MODE	Five ways: constant torque V/F curve, 1 kind of user defined V/F curve, 3 kinds of down torque curve (2.0 / 1.7 / 1.2times the power)
AUTOMATIC ENERGY SAVING OPERATION	Saving energy by auto optimizing V/F curve according to the load
AUTOMATIC VOLTAGE REGULATION	Regulates the voltage automatically whenever there is a change in grid voltage
OPERATION COMMANDS	Keypad, External terminals and Communication
FREQUENCY SETTING	Digital setting, Analog voltage setting, Analog current setting, Communication
INPUT SIGNAL	Forward / Reverse, Jogging selection, Multi speed control, Regular stopping
OUTPUT SIGNAL	Fault alarm output (250V/2A Contact), Open collector output
PROTECTION FUNCTIONS	Over current, Over voltage, Under voltage, Over heat, Overload, Phase loss
DISPLAY	Parameters setting, Running status and fault display
OPERATING ENVIRONMENT	Temperature : -10 ~ +50°C, Humidity : < 90%, No condensation, IP20
OPERATIONS AREA	Indoor, <1000m altitude above sea level
STORAGE TEMPERATURE	-20 ~ +60°C
VIBRATION	<5.9 m/s <sup>2</sup> (0.6g)
INPUT CHANNEL	6 DIs (Internal impedance : 3.3kΩ), 2AIs (0-10V, 0-10V/0-20mA)
OUTPUT CHANNEL	1 RO, 2 TO, 1AO (0-10V/0-20mA)
APPLICATIONS	Suitable for Fans, Pumps, Conveyor, Food & drink packaging machinery, Industrial washing machine, Winder application, Hoists, Paper Mills, Textile Applications and most general industries etc.

## Ordering information

### Variable Frequency Drive (FD9)

PRODUCT CODE	DESCRIPTION	CERTIFICATION
FD9-1-002-C-CE	1 PH 230VAC IN, 3 PH 0~230VAC 0.25HP/0.2kW	CE
FD9-1-005-C-CE	1 PH 230VAC IN, 3 PH 0~230VAC 0.5HP/0.4kW	CE
FD9-1-010-C-CE	1 PH 230VAC IN, 3 PH 0~230VAC 1HP/0.7kW	CE
FD9-1-020-C-CE	1 PH 230VAC IN, 3 PH 0~230VAC 2HP/1.5kW	CE
FD9-3-005-C-CE	3 PH 415VAC IN, 3 PH 0-415VAC OUT 0.5HP/0.4kW	CE
FD9-3-010-C-CE	3 PH 415VAC IN, 3 PH 0-415VAC OUT 1HP/0.7kW	CE
FD9-3-020-C-CE	3 PH 415VAC IN, 3 PH 0-415VAC OUT 2HP/1.5kW	CE
FD9-3-030-C-CE	3 PH 415VAC IN, 3 PH 0-415VAC OUT 3HP/2.2kW	CE
FD9-3-050-C-CE	3 PH 415VAC IN, 3 PH 0-415VAC OUT 5HP/3.75kW	CE
FD9-3-075-C-CE	3 PH 415VAC IN, 3 PH 0-415VAC OUT 7.5HP/5.5kW	CE
FD9-3-100-C-CE	3 PH 415VAC IN, 3 PH 0-415VAC OUT 10HP/7.5kW	CE
FD9-3-150-C-CE	3 PH 415VAC IN, 3 PH 0-415VAC OUT 15HP/11kW	CE

PRODUCT CODE	DESCRIPTION	CERTIFICATION
FD9-3-200-C-CE	3 PH 415VAC IN, 3 PH 0-415VAC OUT 20HP/15kW	CE
FD9-3-250-C-CE	3 PH 415VAC IN, 3 PH 0-415VAC OUT 25HP/18.5kW	CE
FD9-3-300-C-CE	3 PH 415VAC IN, 3 PH 0-415VAC OUT 30HP/22.4kW	CE
FD9-3-400-C-CE	3 PH 415VAC IN, 3 PH 0-415VAC OUT 40HP/30kW	CE
FD9-3-500-C-CE	3 PH 415VAC IN, 3 PH 0-415VAC OUT 50HP/37.5kW	CE
FD9-3-600-C-CE	3 PH 415VAC IN, 3 PH 0-415VAC OUT 60HP/45kW	CE
FD9-3-750-C-CE	3 PH 415VAC IN, 3 PH 0-415VAC OUT 75HP/55kW	CE
FD9-3-1000-C-CE	3 PH 415VAC IN, 3 PH 0-415VAC OUT 100HP/75kW	CE
FD9-3-1200-C-CE	4 PH 415VAC IN, 3 PH 0-415VAC OUT 120HP/90kW	CE
FD9-3-1500-C-CE	3 PH 415VAC IN, 3 PH 0-415VAC OUT 150HP/110kW	CE
FD9-3-1750-C-CE	3 PH 415VAC IN, 3 PH 0-415VAC OUT 175HP/132kW	CE
FD9-3-2100-C-CE	3 PH 415VAC IN, 3 PH 0-415VAC OUT 210HP/160kW	CE

## Panel Cutout Dimensions (All are in mm)

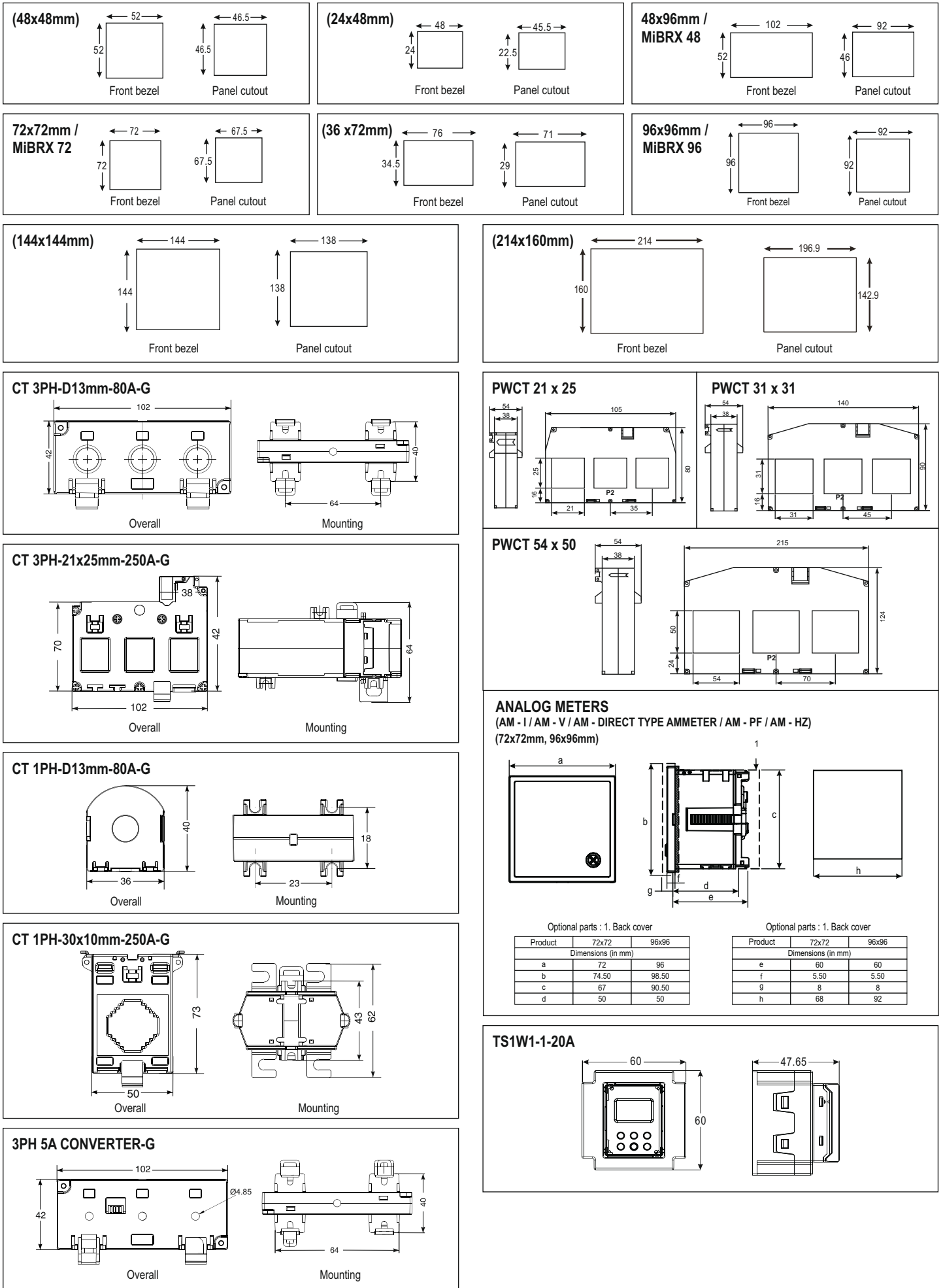

### ANALOG METERS (AM - I / AM - V / AM - DIRECT TYPE AMMETER / AM - PF / AM - HZ) (72x72mm, 96x96mm)

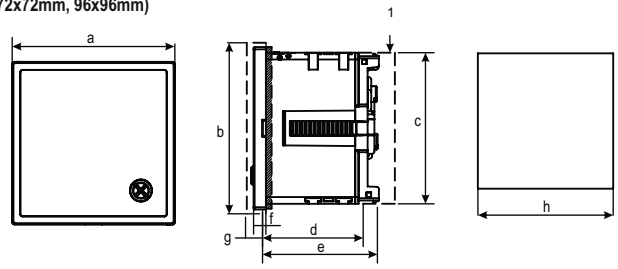

Optional parts : 1. Back cover

Product	72x72	96x96
Dimensions (in mm)		
a	72	96
b	74.50	98.50
c	67	90.50
d	50	50

Optional parts : 1. Back cover

Product	72x72	96x96
Dimensions (in mm)		
e	60	60
f	5.50	5.50
g	8	8
h	68	92

### TS1W1-1-20A

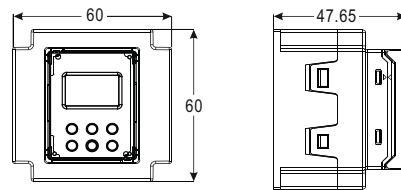

**Panel Cutout Dimensions** (All are in mm)

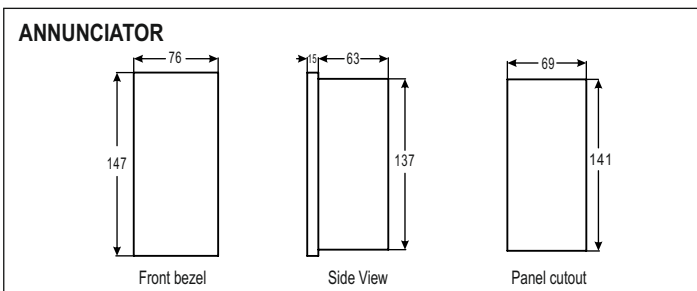
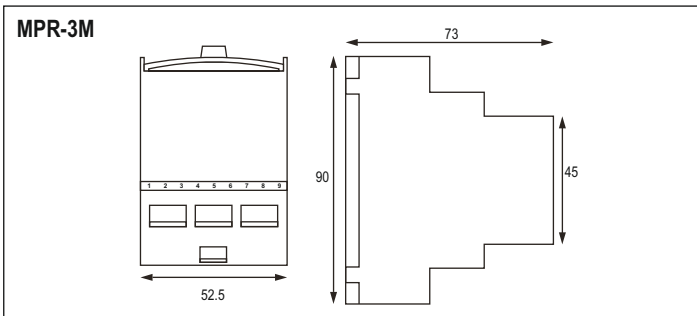
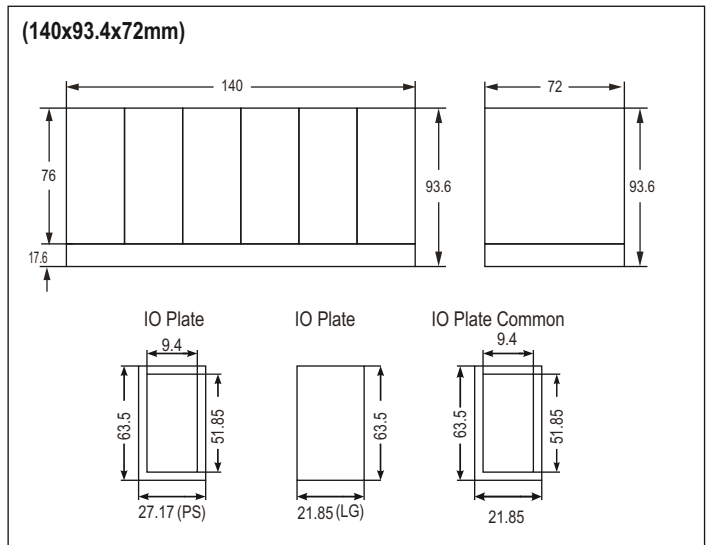
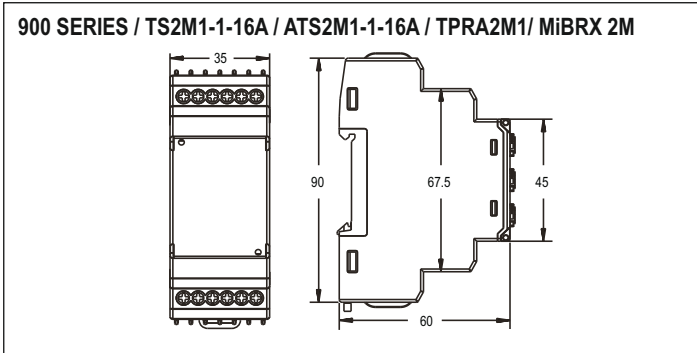
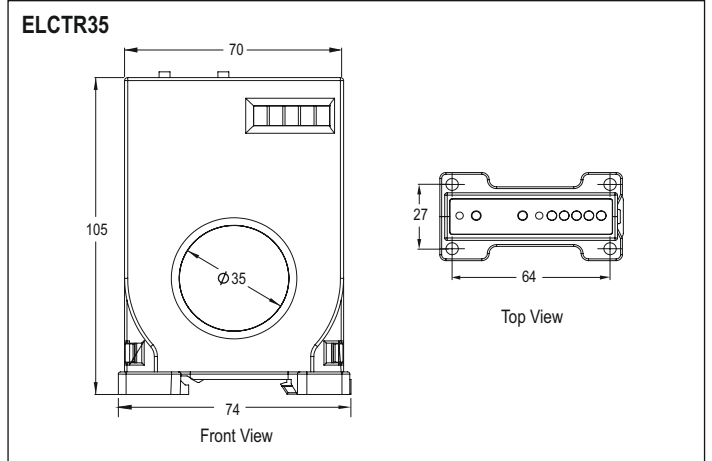
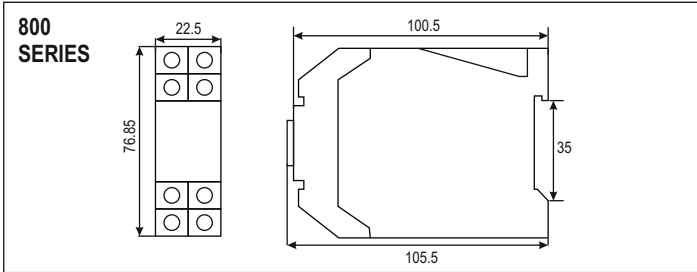
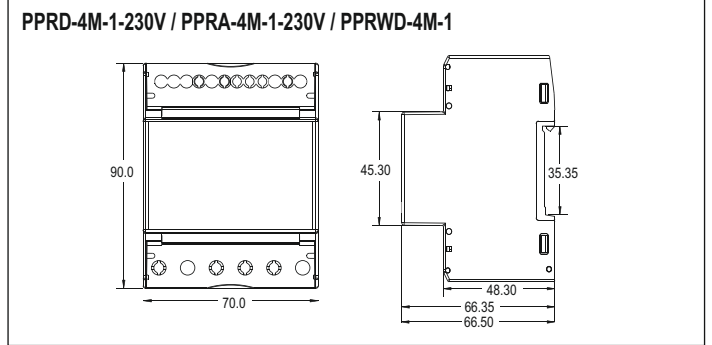
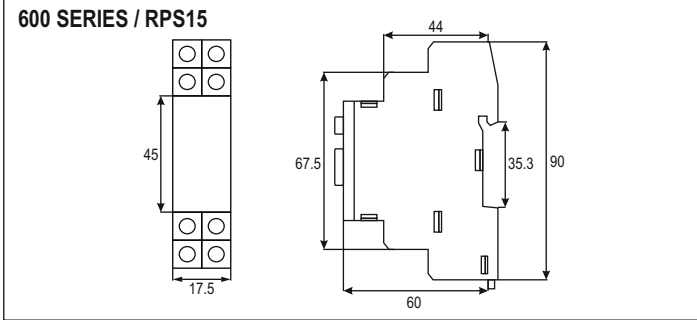
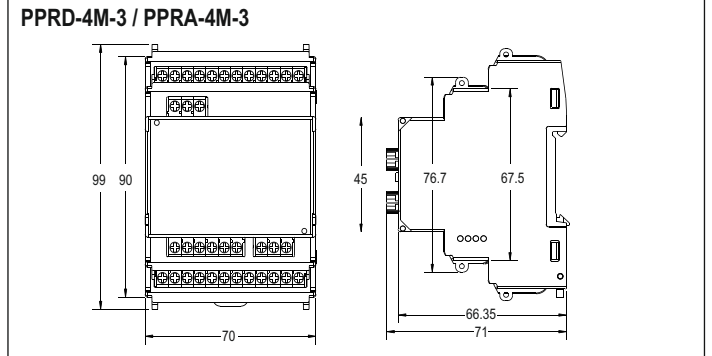
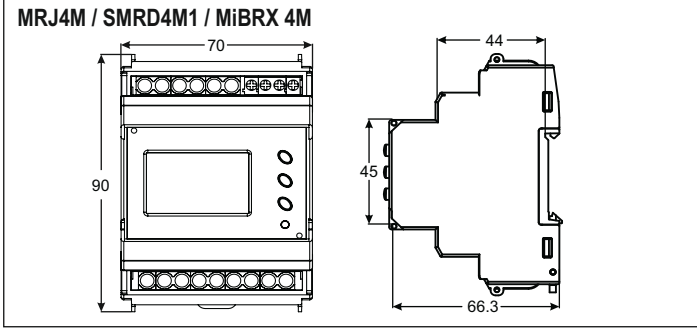

## Panel Cutout Dimensions ( All are in mm )

**RP-2M-1.1A-24VDC / RPS40**

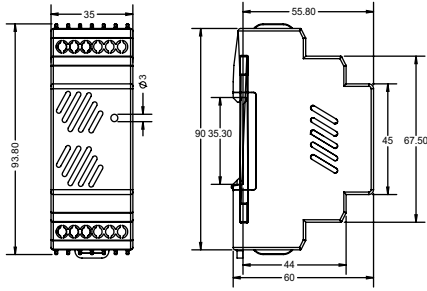

**BC2-2410**

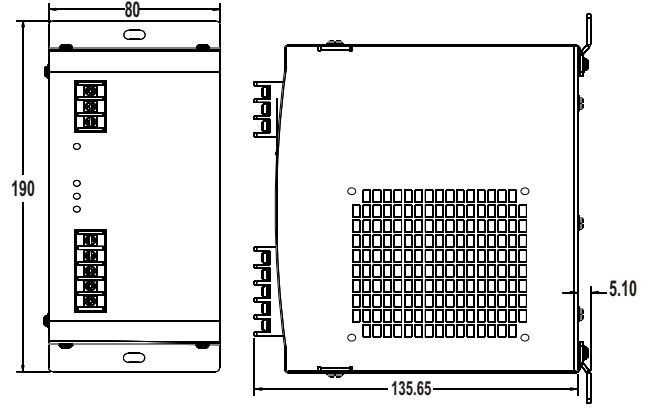

**RPS60 / RPS120**

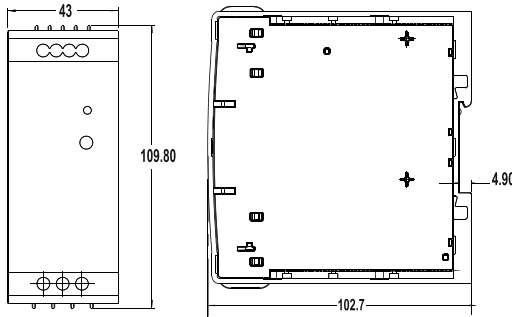

**OPS2x3-40**

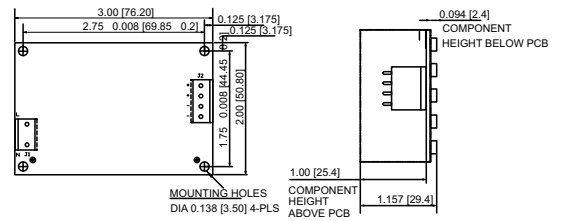

**RPS240**

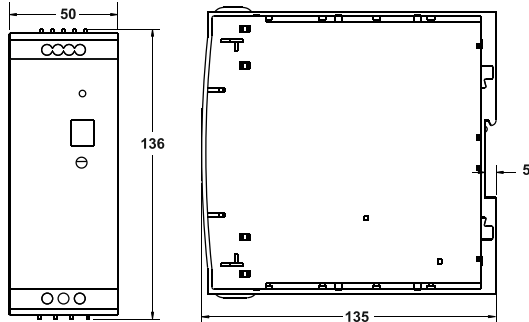

**OPS2x4-60**

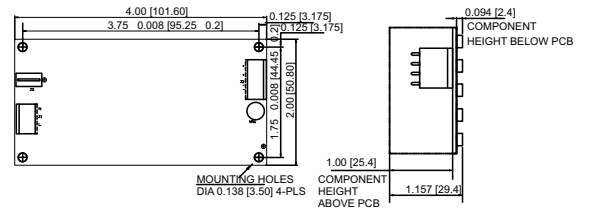

**OPS2x4-150**

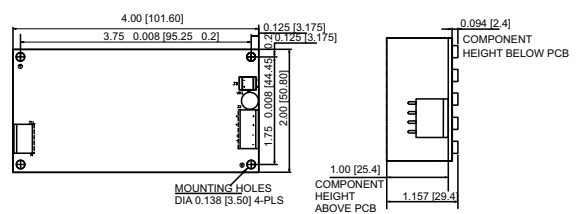

**RPS480 / LRPS240**

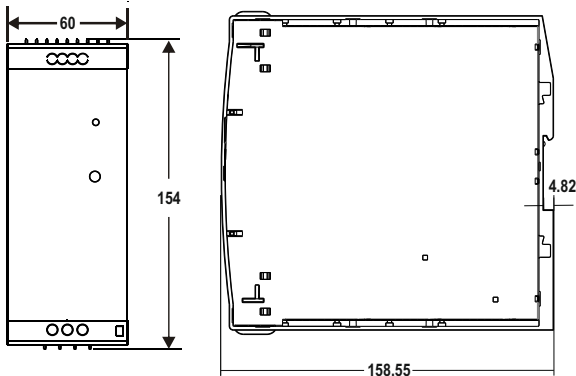

**OPS2x4-200**

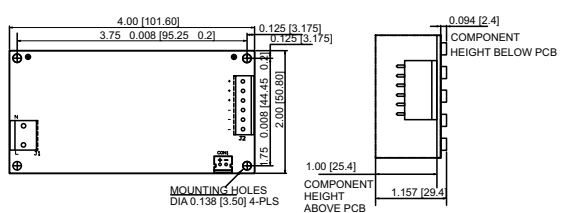

**BC1-1210**

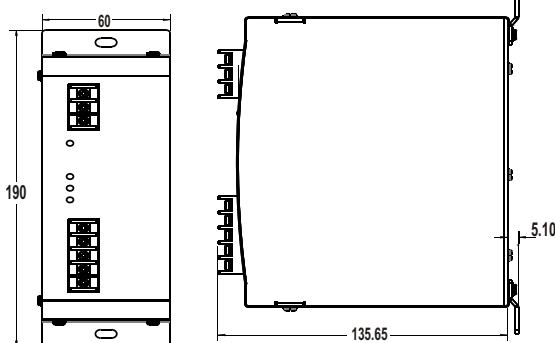

**OPS3x5-350**

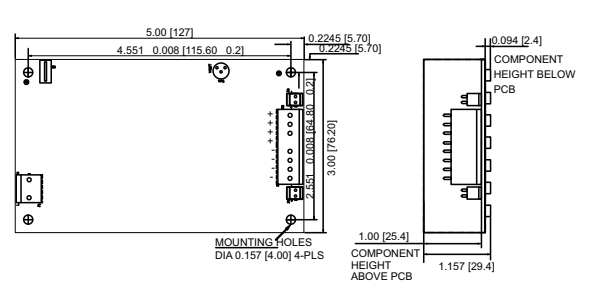

**Note :** This open frame power supply should preferably be mounted horizontally on 4 metal stand-offs having diameter not more than 6mm and height not less than 5mm

## Panel Cutout Dimensions (All are in mm)

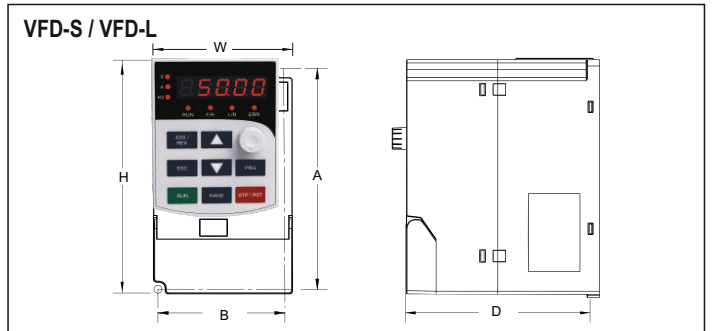
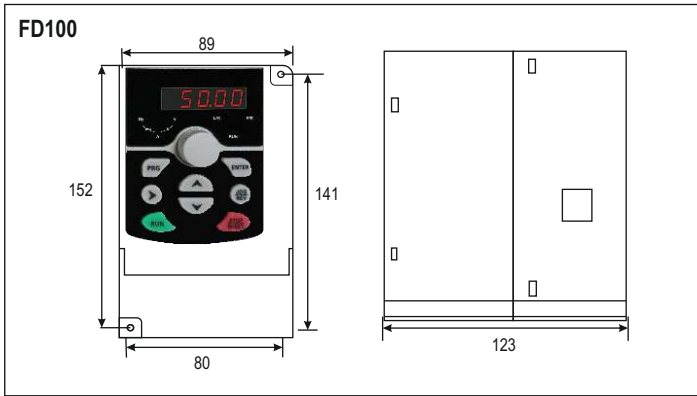

Product code	Mounting dimension		Dimension			Pore diameter (mm)
	A	B	H	W	D	
VFD-S-1-005-230V	141	80.5	150	89	123	5.2
VFD-S-1-010-230V						
VFD-S-1-020-230V						
VFD-S-3-010-415V						
VFD-S-3-020-415V						
VFD-S-3-030-415V	240	148	247	160	173	10
VFD-SH-3-050-B-415V						
VFD-SN-3-075-B-415V						
VFD-SH-3-075-B-415V						
VFD-SN-3-100-B-415V						
VFD-SH-3-100-B-415V	305	205	320	220	196.5	10
VFD-SH-3-150-B-415V						
VFD-SN-3-200-B-415V						
VFD-SH-3-200-B-415V						
VFD-SN-3-250-B-415V						
VFD-L-1-005-230V	141	80.5	152	90	123	5.2
VFD-L-1-010-230V						

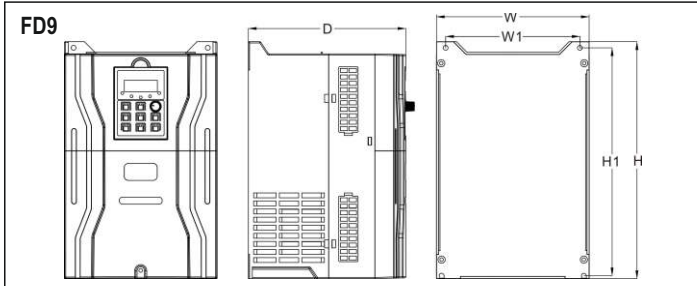

Product Code	Dimension (mm)			Installation (mm)			
	H	W	D	H2	H1	W1	Mount hole
FD9-1-002-C-CE	174	76	131	---	162.5	58	Φ5
FD9-1-005-C-CE							
FD9-1-010-C-CE							
FD9-1-020-C-CE							
FD9-3-005-C-CE	174	76	131	---	162.5	58	Φ5
FD9-3-010-C-CE							
FD9-3-020-C-CE							
FD9-3-030-C-CE							
FD9-3-050-C-CE	184	98	156	---	178	88	Φ5
FD9-3-075-C-CE	230	118	173	---	220	108	Φ5
FD9-3-100-C-CE							
FD9-3-150-C-CE	261	130	190	---	251	120	Φ5
FD9-3-200-C-CE	293	190	196	---	283	180	Φ5
FD9-3-250-C-CE							
FD9-3-300-C-CE	445	280	200	---	435	270	Φ5
FD9-3-400-C-CE							
FD9-3-500-C-CE	505	320	240	---	495	310	Φ5
FD9-3-600-C-CE	555	310	260	---	545	300	Φ5
FD9-3-1000-C-CE	650	400	300	---	640	390	Φ5
FD9-3-1200-C-CE							
FD9-3-1500-C-CE							
FD9-3-1750-C-CE							
FD9-3-2100-C-CE	760	390	320	---	750	380	Φ5

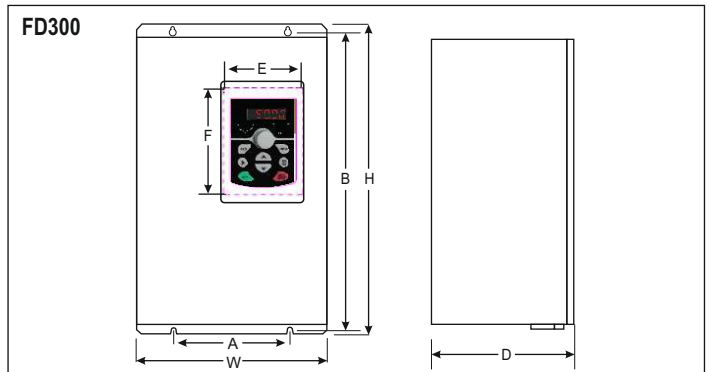

Product code	Mounting dimension		Dimension			Pore diameter
	A (mm)	B (mm)	H (mm)	W (mm)	D (mm)	
FD300-3-050-C-CE	107	175	185	118	167	f4.5
FD300-3-075-C-CE						
FD300-3-100-C-CE	148	235	247	160	190	Φ5.5
FD300-3-150-C-CE						
FD300-3-200-C-CE						
FD300-3-250-C-CE						
FD300-3-300-C-CE	205	305	320	220	205	Φ5.5
FD300-3-400-C-CE						
FD300-3-500-C-CE	180	416	432	255	234.5	Φ7
FD300-3-600-C-CE						
FD300-3-750-C-CE	244	497	518	300	260	Φ9
FD300-3-1000-C-CE						
FD300-3-1200-C-CE	300	598	620	390	300	Φ11
FD300-3-1500-C-CE						
FD300-3-1750-C-CE	350	745	780	480	360	Φ12
FD300-3-2100-C-CE						

Subsidiaries : **Selec GmbH** | **Selec USA** | **Selec Australia**

**Head Office :**

**Selec Controls Pvt. Ltd.**

EL-27/1, Electronic Zone, TTC Industrial Area, MIDC, Mahape, Navi Mumbai 400710, INDIA.

Tel.: +91-22-4141 8468 / 452. Fax: +91-22-41418 408. Email: sales@selec.com | [www.selec.com](http://www.selec.com)

**Selec USA :** [www.selec.com/us/en](http://www.selec.com/us/en) | **Selec GmbH :** [www.selec-europe.com](http://www.selec-europe.com) | **Selec Australia :** [www.selec.com/au/en](http://www.selec.com/au/en)